

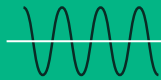

# NI Product Catalog

Test



Automate



Measure

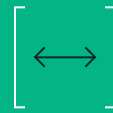

2022

# NI Product Catalog

## 03 What Makes NI Different for Test and Measurement

Find NI Anywhere There is Test

## 07 Why Choose NI Software for Test

Drag and Drop to Build a Custom Test Panel

NI Software Connects to Anything for Your Test System

## 10 Software Selection Guide

NI Software Products

## 12 Get Access to All the Software You Need in a Single Bundle: Test Workflow

What Can You Do with Test Workflow?

LabVIEW

G Web Development Software

TestStand

DIAdem

FlexLogger

InstrumentStudio Software

## 21 NI Hardware Products

How to Shop for NI Systems

Platform Selection Sheet

## 25 PC-Based Data Acquisition (Multifunction I/O and Reconfigurable I/O)

Multifunction I/O: PCIe, USB

Reconfigurable I/O: PCIe, USB

## 28 Modular Data Acquisition for Sensors and Electrical Signals

CompactDAQ

Steps for Building a cDAQ System

## 30 High-Speed Control with Built-In Computer

CompactRIO

Steps for Building a cRIO System

Measurement & Control Modules (C Series Modules)

## 34 PXI Systems

Steps for Building a PXI Test and Measurement System

PXI Instrument Overview

PXI Oscilloscopes

PXI Digital Multimeters

PXI Counter/Timer

PXI Power Supply

PXI Switches

PXI LCR Meter

PXI Digital Instruments

PXI Waveform Generator

PXI Source Measure Units (SMU)

PXI Reconfigurable IO Module (FPGA)

PXI Digital Waveform Instrument

Multifunction I/O

PXI Sound and Vibration Modules

PXI Signal Conditioning Modules

## 52 RF

Vector Signal Transceiver

RFmx

Software Defined Radios

## 56 Instrument Control: GPIB, Serial

## 57 NI Partner Network

Types of Partners

## 58 Services

Hardware Services

Education Services

Technical Support Services

# What Makes NI Different for Test and Measurement

At our core, we're passionate about test technology and improving product performance. We know your research or latest product design will move markets and improve the world we live in. We're here to help you Engineer Ambitiously.

## We Are Software-Obsessed

NI products are designed for software. From simple USB devices to advanced RF testbeds, engineers working with NI systems see software as a defining element of test.

## Our Hardware is Modular

You may be used to purpose-built boxed instruments; when you need a new measurement or more channels, you buy a whole new box. With NI hardware, you change or add measurements by adding new modules. Just like you upgrade your PC with a new graphics card, you can upgrade your NI test system with a new Oscilloscope module.

## The NI Ecosystem is Open

Test engineers benefit most when they combine NI software with NI hardware, but NI hardware works with other (non-LabVIEW) popular programming languages and NI software connects to non-NI hardware. Choose the tools that work for you.

## Why NI for Test

Every company says they save you time and money. Here are the challenges NI solves to do it.



### Flexibility

Changing designs, market needs, and supply chains challenge product development. Use NI tools to adapt and stay on schedule.



### Standardization

Don't spend time and money repeating work. Lower your cost of test by sharing code libraries and hardware architectures amongst all your test teams.



### Quality

NI is known for data throughput, acquisition rates, synchronization, and measurement quality. Better products need better test.







### Productivity

You are a critical part of test. NI improves your productivity, so you focus more on what matters to you, your team, and your business.

# Find NI Anywhere There is Test

NI works with more than 40,000 customers each year to deliver the test and measurement technology engineers use to deliver better products, on time, while driving down the cost of test. Find NI anywhere there is test, including:

<p><b>QUICK DESKTOP MEASUREMENTS TO TEST DESIGN ASSUMPTIONS</b></p>	<p><b>MECHANICAL AND SENSOR-BASED TESTS TO VALIDATE SPECIFICATIONS</b></p>	<p><b>AUTOMATED SOFTWARE (HIL) TEST RACKS TO COVER THE WHOLE TEST ENVELOPE IN LESS TIME</b></p>	<p><b>MANUFACTURING TEST SYSTEMS TO IMPROVE TEST QUALITY AND THROUGHPUT</b></p>
			

## Industries Served

- Semiconductor
- Electronics (consumer and industrial)
- Electrical components (motors, switches...)
- White Goods and Appliances
- Automotive
- Aerospace
- Military and Defense
- Life Sciences
- Academic (teaching and research)
- Heavy equipment, Industrial, and Off-Highway
- Commercial and Government Research Labs
- Energy: Smart Grid
- Energy: Renewables Research
- Energy: O&G Mid/Downstream and Well Servicing
- And more...

## Companies and Engineers Seeing Success with NI Today

**Qorvo**

**2X**

doubled test throughput and prepared for 5G

**Hyundai**

**83%**

lower development time for new test systems per variant

**Honeywell**

**40%**

reduction in cost of each test station

**Philips**

**\$2M+**

reduction in OpEx per project

## Philips Rethinks Functional Test, Shortening Time to Market

“The move to a COTS approach using PXI and LabVIEW was critical to this production-test success at Philips. The combination of best-in-class modular hardware along with industry-standard software was pivotal to millions of dollars and hundreds of hours saved in production test engineering.”

**Neil Evans**  
Senior Manager, Philips

## Productivity Boost in Post-Silicon Validation

“It was never easier to configure the PXI instruments and run automated measurement without much coding in a few minutes of setup time. I believe the powerful combination between InstrumentStudio™ and TestStand with the sweep loop is an incredible feature that (will) boost our productivity for debugging activities in post silicon validation.”

**Wolfgang Rominger**  
NXP

## NI Hardware is Modular

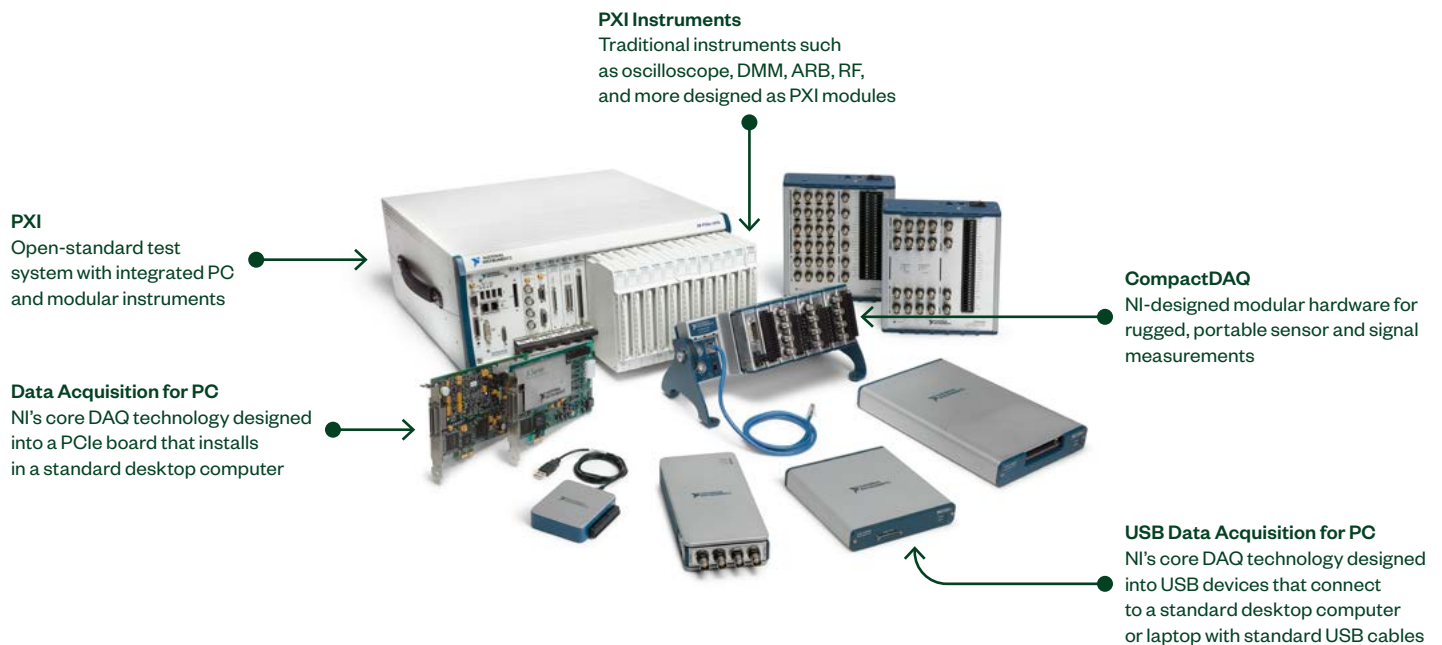

Mix and match NI's modular hardware with a PC to build a custom test and measurement solution for the desktop, lab bench, or production floor.



# Why Choose NI Software for Test

## Program Like You Think with Graphical Development Software

Graphical data flow in LabVIEW (bottom) is like flowchart logic (top) and considered easier by many to interpret and debug.

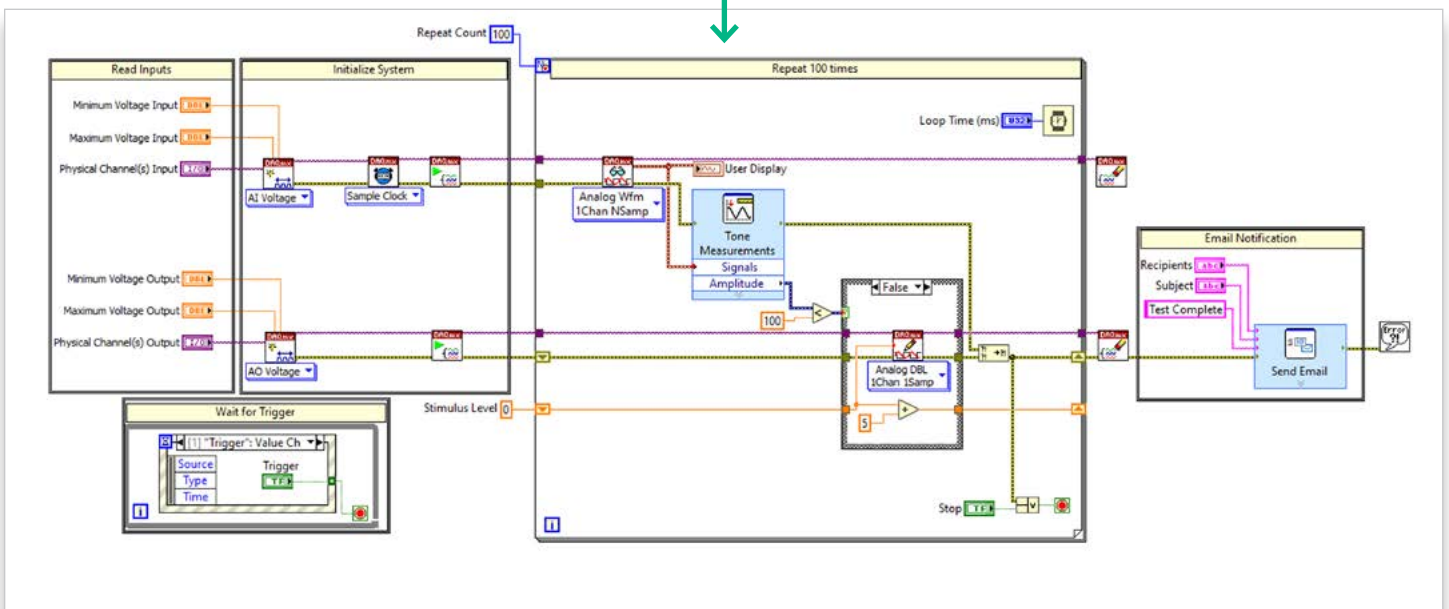
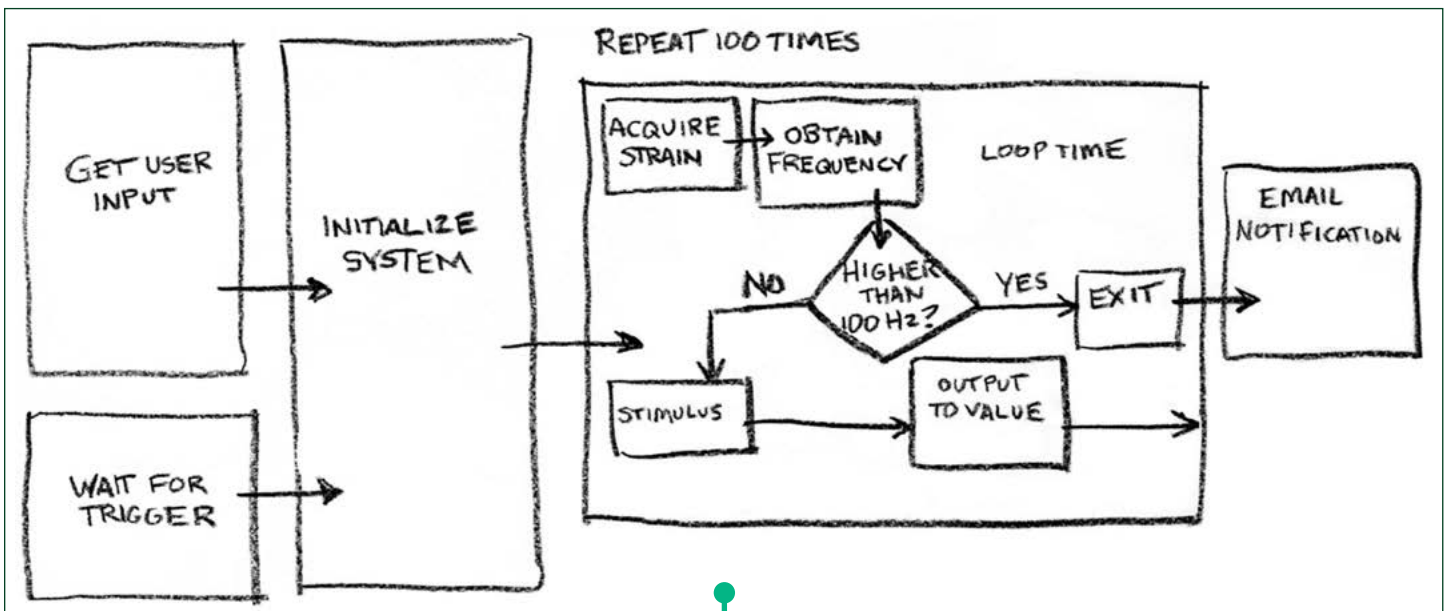

# Drag and Drop to Build a Custom Test Panel

Use drag-and-drop UI elements to build a custom, professional test panel. The UI elements in LabVIEW are designed specifically for engineers building test and measurement systems.

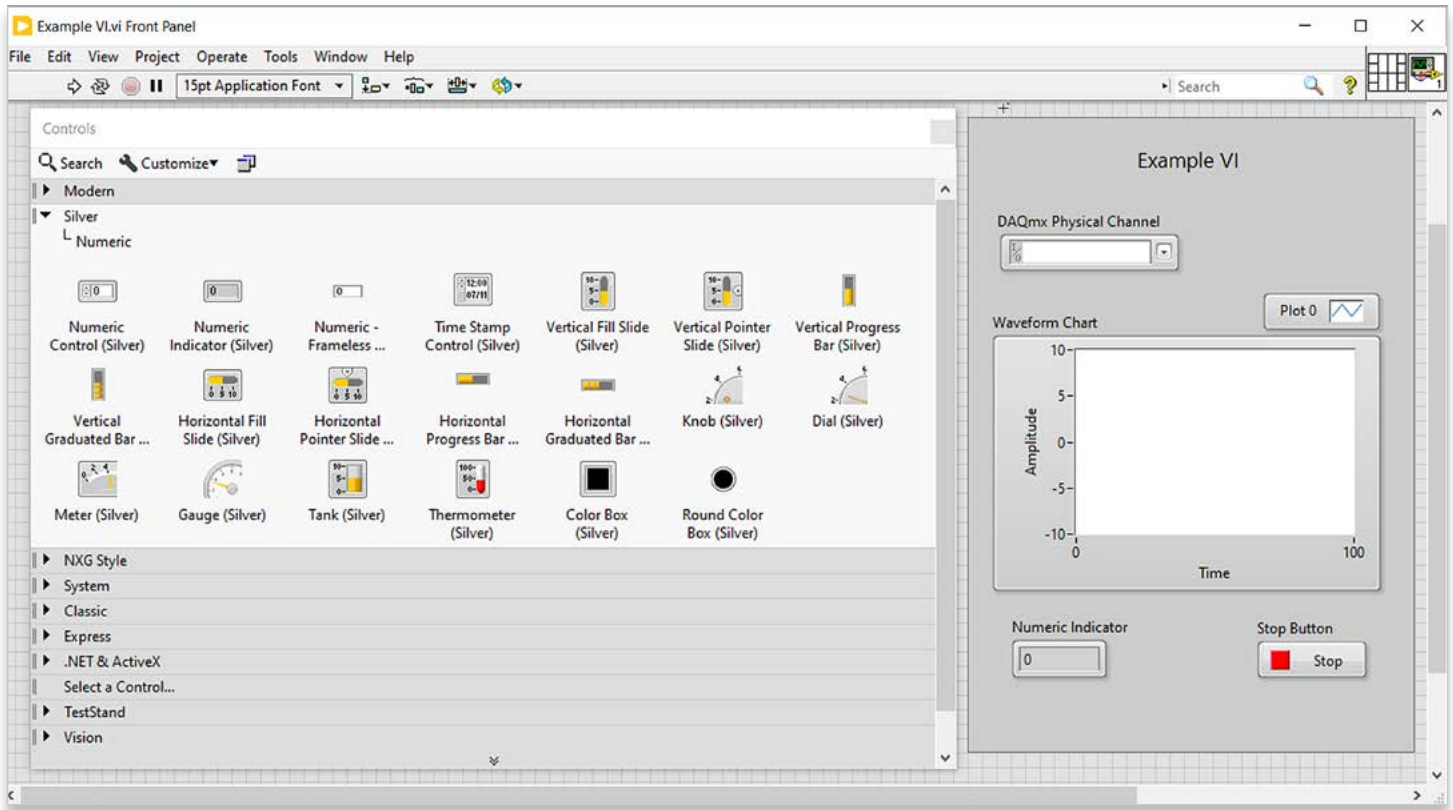

# Integrate Text-Based Code from Other Programming Languages

MATLAB®

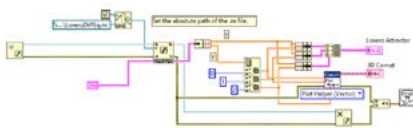

Python

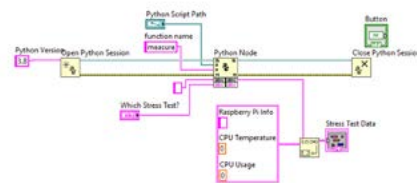

C/C++, C#

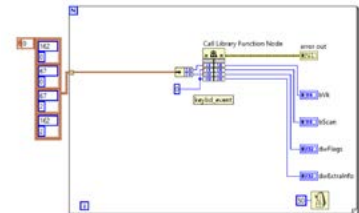

Use hundreds of LabVIEW's built-in analysis and communication blocks or integrate your own with code from popular software and programming languages such as MathWorks® MATLAB® software, Python, C/C++, and C# .NET.



# There's no need to program at all with several no-code application options from NI.

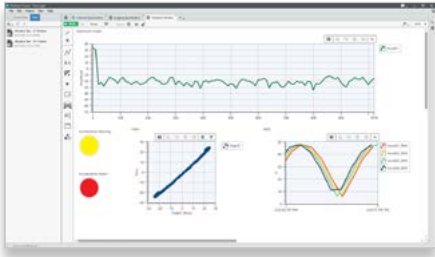

Configure FlexLogger™ data acquisition software for electrical and sensor measurements from NI hardware in minutes

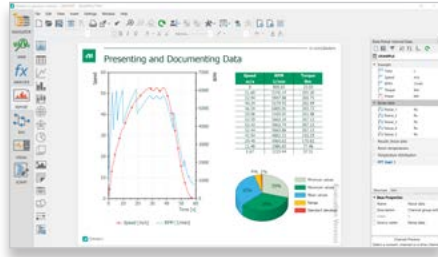

Interact with data for analysis and automated report generation with DIAdem

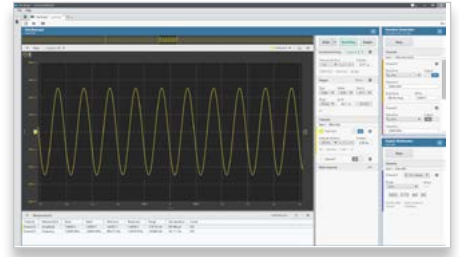

Connect to PXI instruments for interactive measurement and test debugging with InstrumentStudio™

## NI Software Connects to Anything for Your Test System

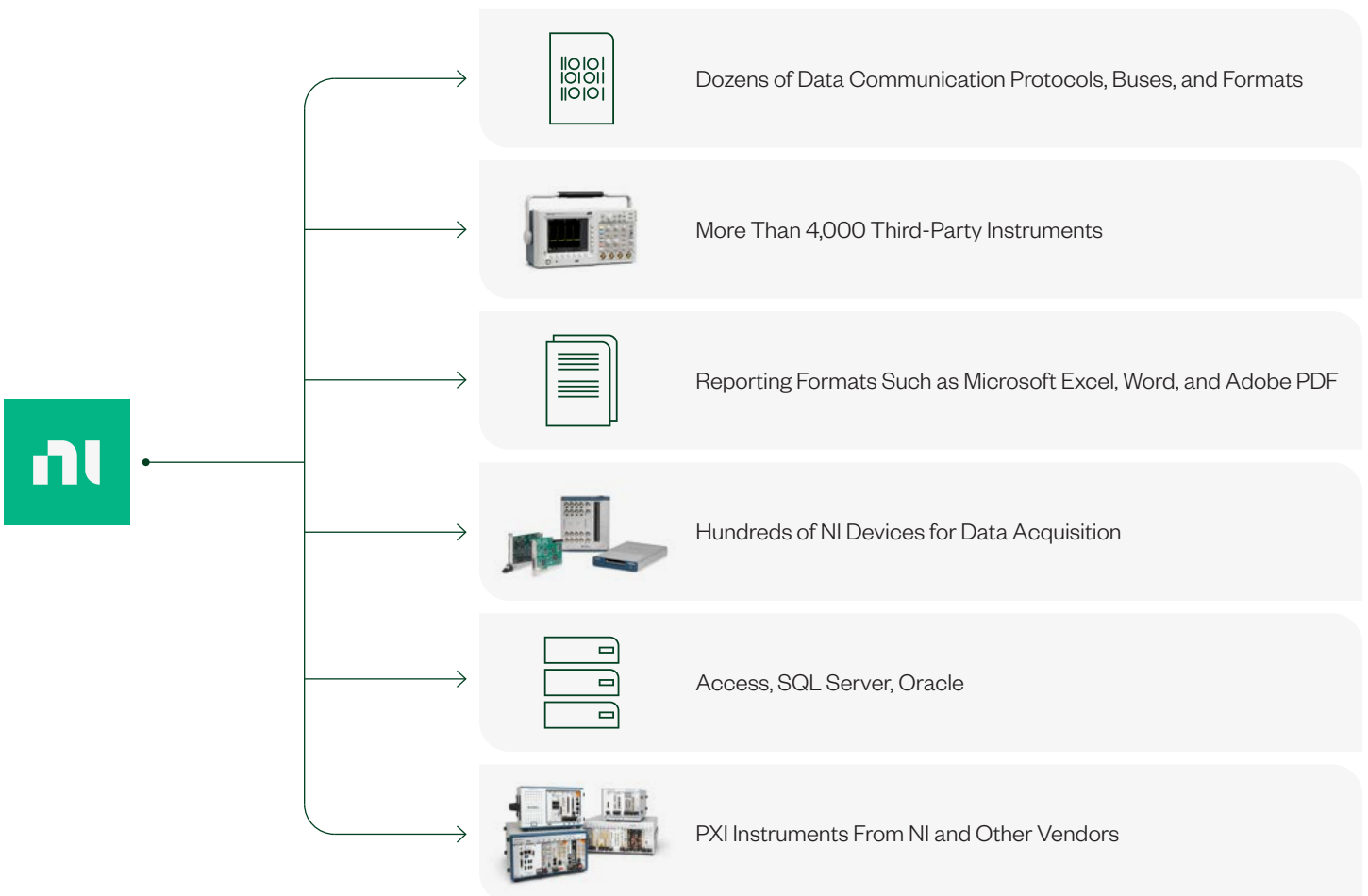

# Software Selection Guide

NI Software can be purchased individually or as part of the Test Workflow software bundle; short descriptions of the software follow. More information on applications and key features can be found in this section.

## NI Software Products

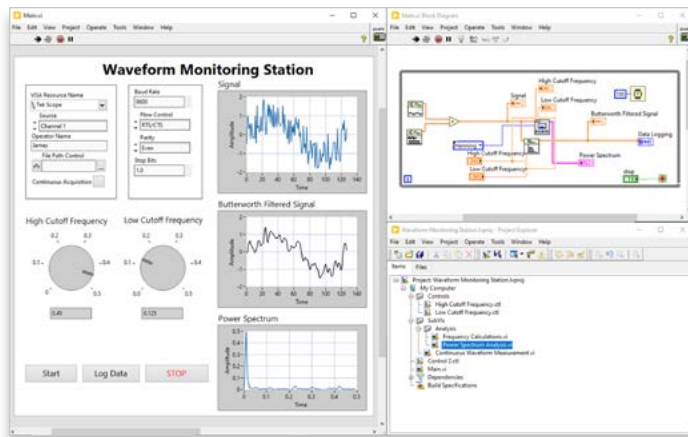

### LabVIEW

A graphical programming environment for developing automated test systems with rapid access to hardware and data insights.

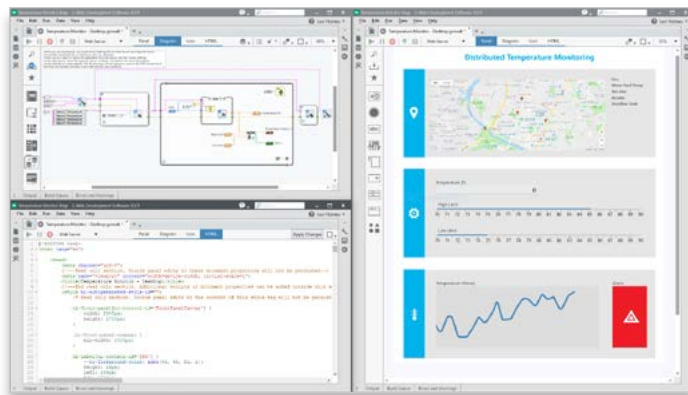

### G Web Development Software

A graphical programming environment optimized for developing web applications for test systems.



### TestStand

Test executive software for developing test sequences for validation and production testers.

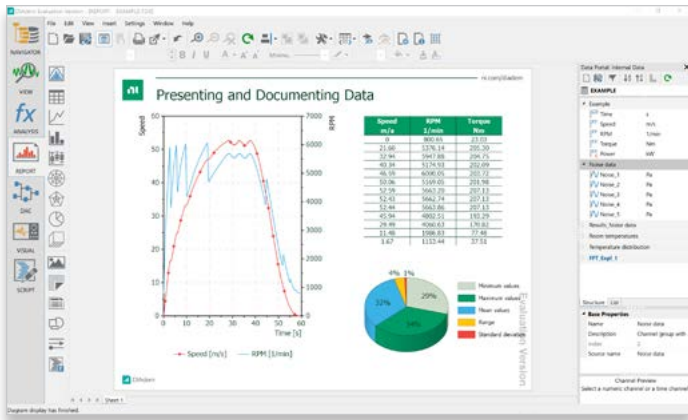

## DIAdem

Data analytics software for measurement data search, inspection, analysis, and automated reporting.

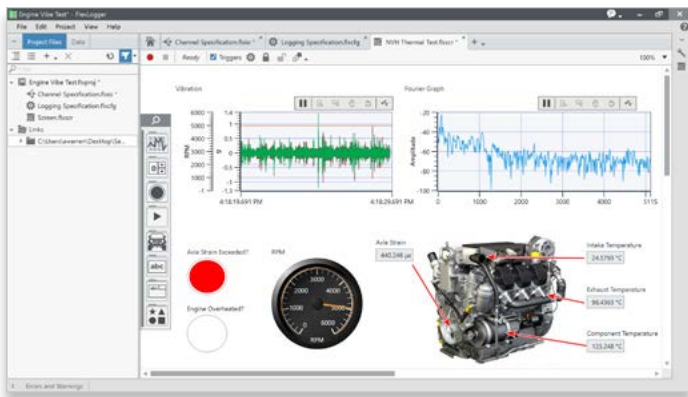

## FlexLogger

No-code software that accelerates measurement configuration and logging with NI DAQ hardware.

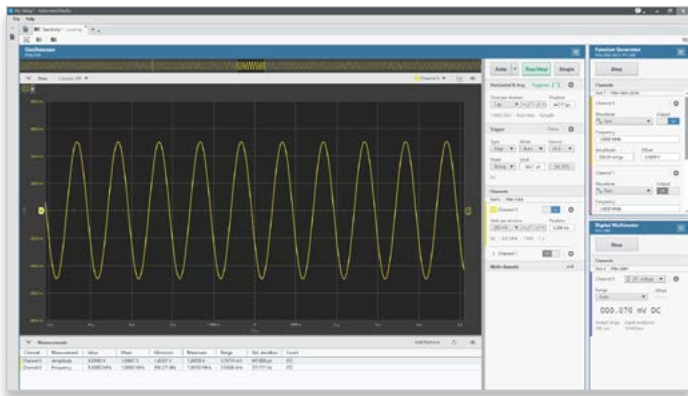

## InstrumentStudio Software

Application software that simplifies setup and configuration of NI PXI hardware.

# Get Access to All the Software You Need in a Single Bundle: Test Workflow

Test Workflow is a bundle of select NI software featuring engineering-specific tools that help test professionals accomplish anything from their day-to-day work to overcoming their most challenging obstacles.

## Test Workflow Standard

Core software for test and measurement in research, validation, and production.



LabVIEW **Full**



DIADEM **Advanced**



FlexLogger Software

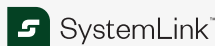

SystemLink Cloud



InstrumentStudio Software

**G Web Development Software**  
**Access to support and training**

## Test Workflow Pro

Additional software and IP for building applications, test management, and advanced analysis.

Everything in Test Workflow Standard, plus:



LabVIEW **Professional**



DIADEM **Professional**

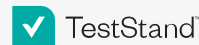

TestStand

**Advanced Signal Processing**  
**Desktop Execution Trace Toolkit**  
**Unit Test Framework**  
**VI Analyzer**  
**Database Connectivity**  
**Report Generation**  
**And more...**

Test Workflow has software for everything test, whether it's getting quick sensor data or building a high-performance test system for production. When you need it, Test Workflow is there to help.

# What Can You Do with Test Workflow?

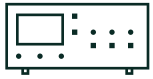

## Control All Your Instruments with One Tool

- Connect to and automate instruments (NI and more than 5,000 non-NI instruments)
- Configure a custom, interactive real-time display for viewing test execution

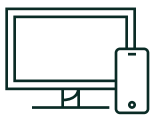

## Access and Control Your Test from Anywhere

- Monitor your test system remotely via web applications developed with Test Workflow
- Host your application on the NI Cloud or on your own server



## Create and Share Automated Reports

- Use drag-and-drop to create graphics and distribute reports to team in common formats
- Automate the data analysis and reporting process with scripts in VBS or Python



## Acquire Data with No-Code Application Software

- Configure hardware channels for a variety of sensor, analog, and digital signals
- Set alarms, log data to disk, and view data on custom real-time displays



## Deploy Royalty-Free Test Applications

- Create stand-alone applications for automating test on multiple systems
- Distribute as applications (.exe) or shared libraries (.dll)

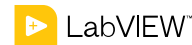

## Optimize Test for Manufacturing

- Create test sequences with code from LabVIEW, Python, C/C++, and .NET
- Leverage parallel testing to run multiple tests on one DUT or multiple DUTs
- Track units and automatically store test results to your database



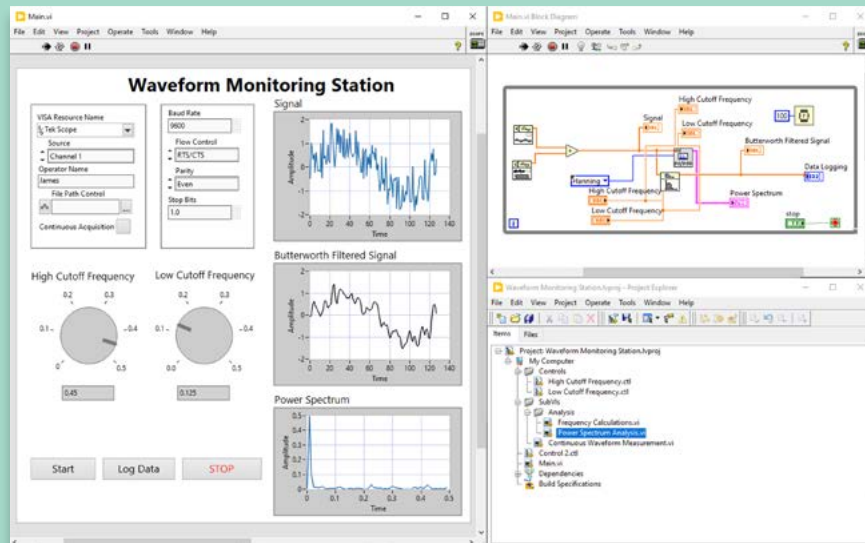

## LabVIEW

LabVIEW is a graphical programming environment engineers use to develop automated research, validation, and production test systems.

Engineers use LabVIEW to:

- Accelerate the development of flexible test systems
- Automate and control any instrument
- Perform data acquisition, analysis, and report generation

### Key Features:

#### Maximize Productivity

- **Graphical Programming**—Visualize your test system with a natural flowchart-like data flow.
- **Customizable User Interfaces**—Create custom user interfaces with pre-built objects for real-time data display, user input, and interactive analysis.

#### Integrate Everything

- **Hardware Access**—Connect to any piece of hardware with thousands of drivers for third-party instrumentation.
- **Code Reuse**—Call existing IP written in Python, C, MathWorks MATLAB software, .NET, and VHDL from your LabVIEW code.

#### Increase Capabilities

- **Real-Time and FPGA Modules**—Use add-ons for applications that require embedded hardware and FPGA systems.
- **Automated Reporting**—Share test results by generating reports for Microsoft Office or writing to a database, such as MongoDB.

- **Active Debugging**—Detect errors faster; LabVIEW recompiles code after every action so you can easily identify and resolve problems with no last-minute surprises.

- **Protocol Support**—Exchange data between applications using TCP/IP, UDP, serial, IrDA, Bluetooth, Modbus, SMTP, and many more.

- **Application Builder**—Create and deploy your code as stand-alone applications for other to use, in just a few clicks.

“The move to a COTS approach using PXI and LabVIEW was critical to this production test success at Philips. The combination of best-in-class modular hardware along with industry-standard software was pivotal to the millions of dollars and hundreds of hours saved in production test engineering.”

Neil Evans  
Senior Manager, Philips

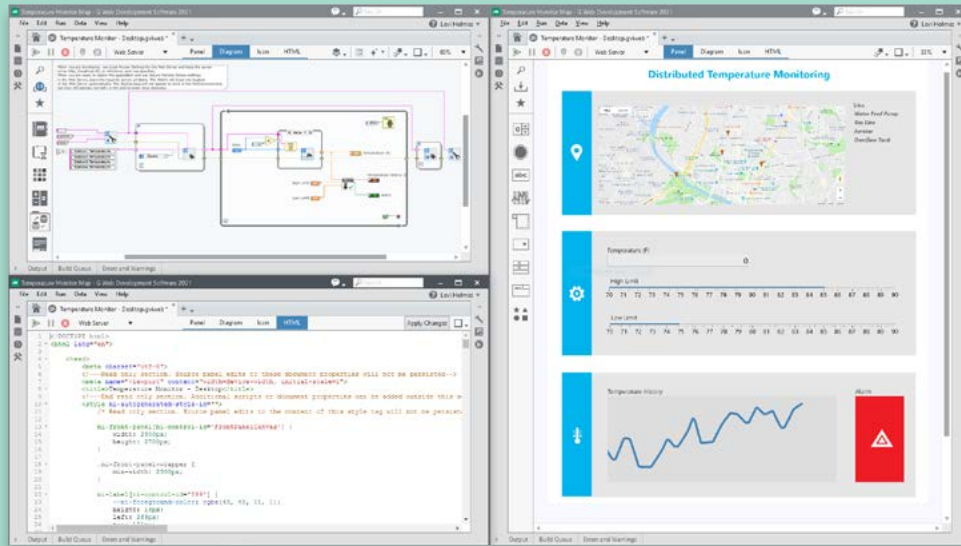

## G Web Development Software

G Web Development Software helps engineers create web-based user interfaces for test and measurement applications without the need for traditional web development skills.

Engineers use G Web Development Software to build web apps for:

- Accessing their test system remotely
- Sharing test information with colleagues
- Accessing their test system on another device

### Key Features:

- **Customizable User Interfaces**—Create custom user interfaces with pre-built objects for data display and user input.
- **Data Communication APIs**—Exchange information with pre-packaged APIs that simplify communication. Compatible with any test system built in LabVIEW, C#, or Python.
- **Hosting**—Host your application on the included cloud-hosting service, SystemLink Cloud, or use the NI Web Server on your test machine or a dedicated server.

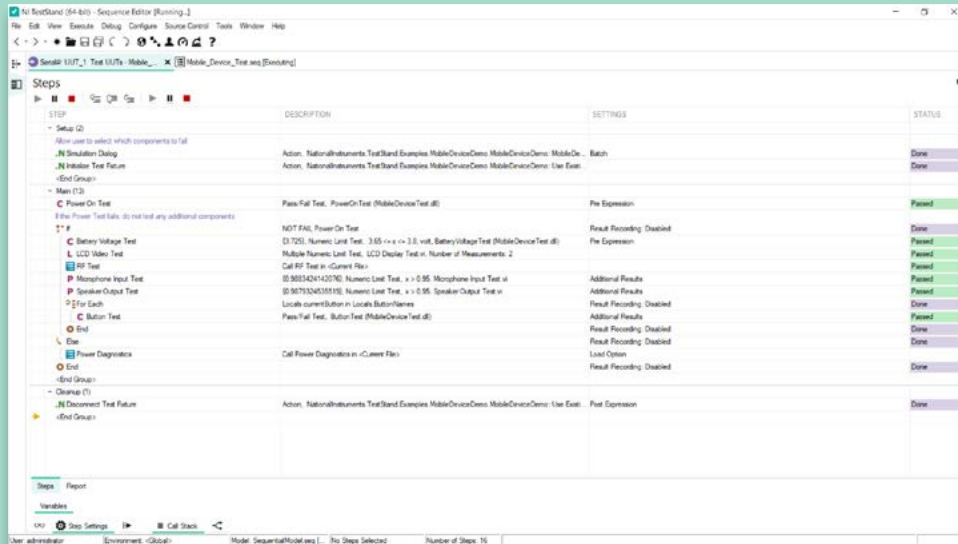

## TestStand

TestStand is test executive software that accelerates system development and deployment for engineers in validation and production.

### Engineers use TestStand to:

- Rapidly develop, deploy, and manage automated test systems
- Test products in parallel to optimize instrument use and test times with built-in autoscheduling intelligence
- Execute tests written in a wide variety of software languages
- Easily log and share test results to local and network databases

### Key Features:

#### Develop Systems Faster

- **Ability to Execute Code Modules Written in Multiple Test Languages**—Take advantage of investments in existing test code by integrating with LabVIEW, Python, LabWindows™/CVI software, C#, C++, Microsoft Visual Basic .NET, and more.
- **Drag-and-Drop Development Environment**—Use the TestStand Sequence Editor to quickly sequence, configure, and execute test code modules.

#### Simplify System Deployment

- **TestStand Deployment Utility**—Easily package all required DLLs, source code, drivers, and configuration information into a single installer.
- **Deployment Patching**—Reduce the difficulty of maintaining deployed test stations by building small deployment patches that can be quickly downloaded and installed on target machines.

#### Increase Test Throughput

- **Autoschedule Hardware Resources**—Minimize equipment costs by sharing hardware among multiple threads by using built-in autoscheduling steps.
- **Simplify Parallel Testing**—Leverage multicore processors when scaling from single-unit testing to multiple-unit parallel testing.

#### Record and Publish Test Results

- **Enterprise Connectivity**—Log test results using standard database connectivity or optimized plug-ins for specialized data management systems, such as SystemLink.
- **Built-In Reporting**—Log critical results to several industry-standard report formats, such as ATML, XML, HTML, and ASCII.

“Using NI TestStand and LabVIEW, we successfully converted a lengthy manual test process into a highly automated test cycle and reduced the regression test cycle from weeks to days, while increasing reliability, repeatability, and maintainability.”

**Sambit Panigrahi**  
Texas Instruments



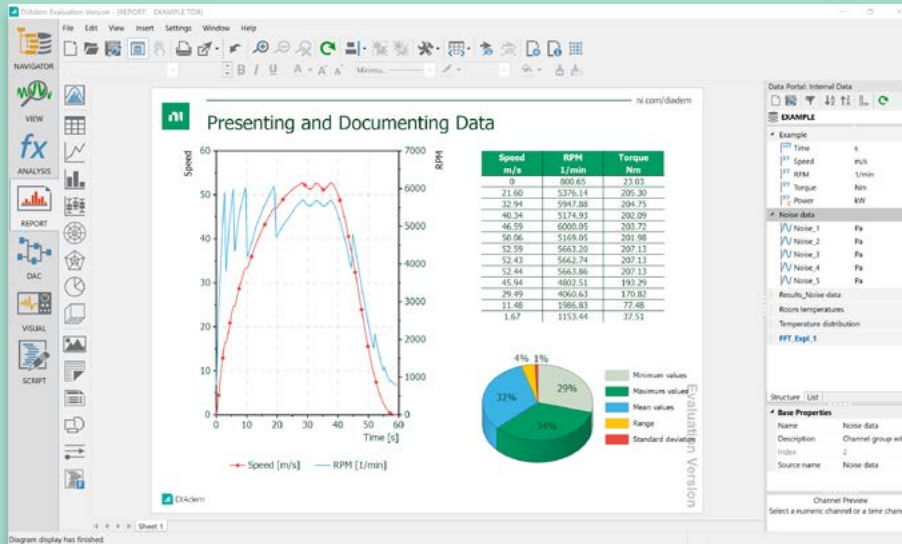

## DIAdem

DIAdem is data analytics software for measurement data search, inspection, analysis, and automated reporting.

Engineers use DIAdem to:

- Find and access data
- Visualize multiple types of test data
- Save time by automating analysis routines and report generation

### Key Features:

- DataPlugins**—DIAdem can import more than 1,000 file types through a technology called DataPlugins. Utilize the 200+ existing DataPlugins or create your own using an interactive Wizard or API.
- Data Display**—Instantly display data in multiple 2D-axis systems, tables, play audio and video data, and view map data. Use paneled display to view multiple datasets with different layouts in one window.
- Built-In Functions**—Transform your data with a simple point-and-click interface to perform analysis.
- Script**—Automate your measurement data analysis workflow, from import to analysis to report, by writing scripts in Python and VBS.

“We have reduced our reporting and analysis time by 95 percent and achieved our goal of replacing the current multi-step process with a one-button DIAdem solution.”

**Jim Knuff**  
Raytheon Missile Systems

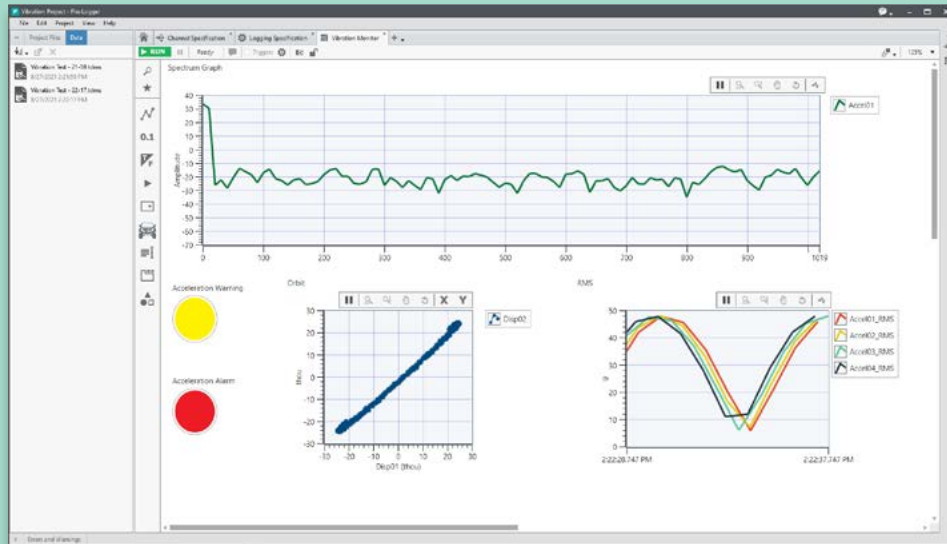

## FlexLogger

FlexLogger is no-code software that accelerates measurement configuration and logging with NI DAQ hardware.

Engineers use FlexLogger to:

- Quickly acquire data to validate designs or assumptions
- Build configurable test systems with a custom UI for operators
- Log data from sensors and electrical signals to disk

Key Features:

- **Calculated Channels**—Perform basic arithmetic on measurement channels and log results to file alongside raw data.
- **Alarms and Events**—Set alarms that monitor single channels or groups to be notified of unexpected behavior. Make quick, informed decisions.
- **File Configuration**—Store data according to your test needs. Built-in functionality can partition files according to file size or time specifications during for long-running tests. Save to multiple locations to reduce risk of data loss.

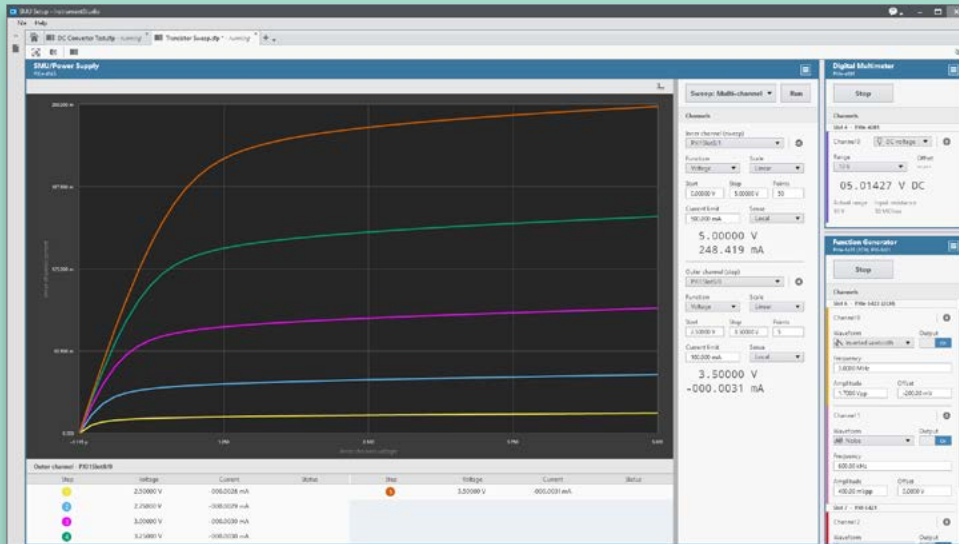

## InstrumentStudio Software

InstrumentStudio software is free application software that provides an integrated approach to interactive PXI measurements.

Engineers use InstrumentStudio software to:

- Integrate instruments into a single view
- Export instrument configurations to code
- Monitor and debug automated test systems

Key Features:

- **Monitor and Debug Automated Test Systems**—Monitor the state of your instruments while they are running or take control of them interactively for debugging.
- **Export Configurations to Code**—Guarantee correlation by replicating instrument configurations in LabVIEW or any other programming environment using a single API function call.
- **Configure Instruments**—Capture multi-instrument screenshots, measurement results, parameter configurations, and UI layouts for broader insight and instant repeatability.

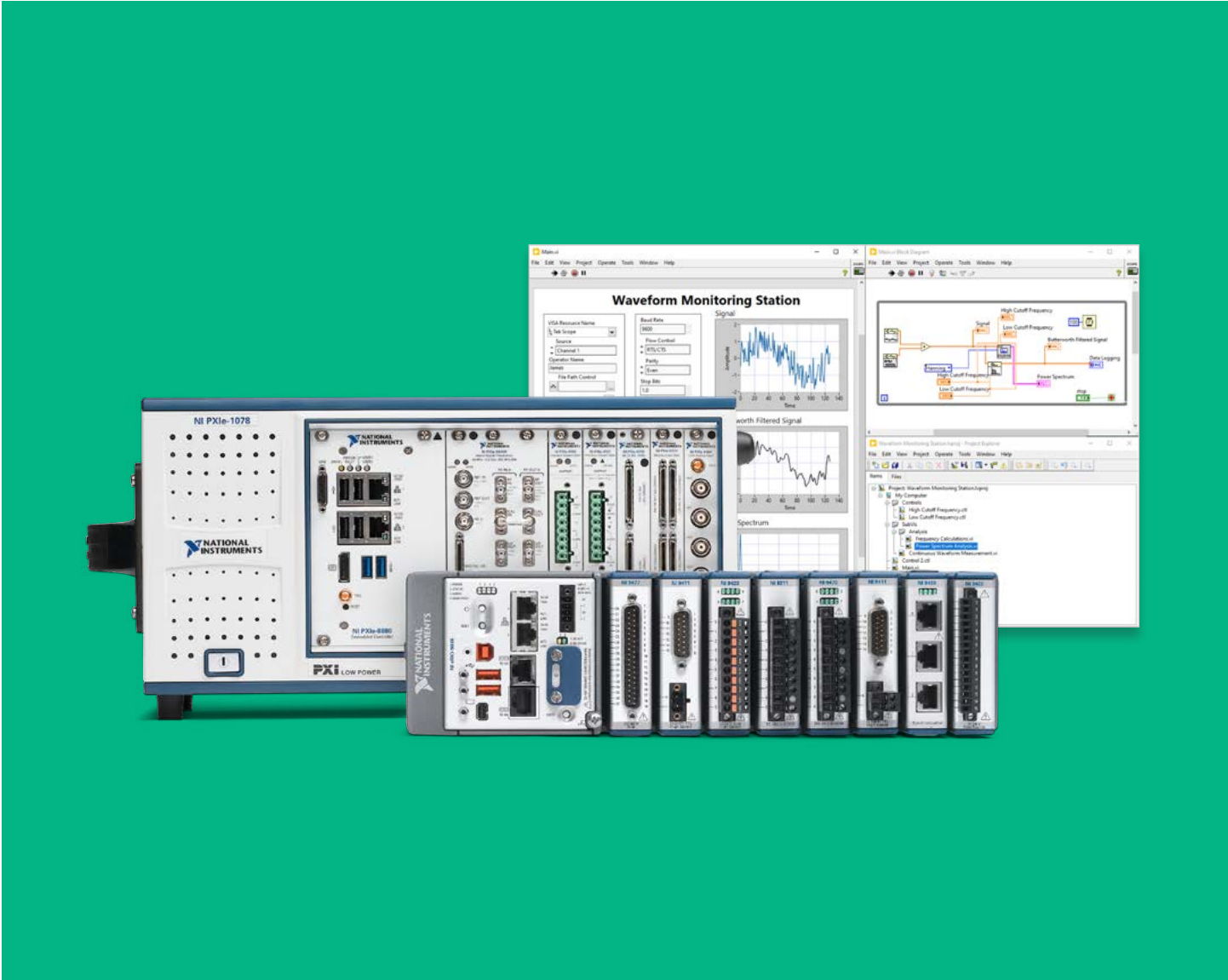

# NI Hardware Products

## How to Shop for NI Systems



### Step 1. Platform

Use the Platform Selection Sheet to find the best hardware platform for you.



### Step 2. Modules

Choose modules by measurement needs: oscilloscopes, multimeters, switches, voltage, current, sensors, etc. Use the selection guides here.



### Step 3. Controller and Chassis (as needed)

For this guide, “controller” means the same thing as a PC or computer; some hardware has the computer built in.



### Step 4. Software

Use the Software Selection Guide. Programming and no-programming options are available.

# Platform Selection Sheet

Use this page to select the NI platform best fit for your needs. The features listed are typical decision factors and not an exhaustive list of capabilities. See the respective hardware sections for more information.



## PC-Based Data Acquisition Systems

- $\pm 10$  V input/output options
- TTL digital lines and counter/timer circuitry
- Support for LabVIEW, Python, C/C#, .NET

### Best for:

- Cost-effective benchtop measurements
- Standard voltage and digital signals
- Install in PC as PCIe boards or connect over USB

[See page 25 for more details.](#)



## Modular Data Acquisition for Sensors and Electrical Signals (CompactDAQ)

- Connects to PC via USB/ENET
- Modular system for expansion
- Rugged operating specs for temperature, shock, and vibration
- Support for LabVIEW, FlexLogger, Python, C/C#, .NET

### Best for:

- High-speed sensor measurements
- Portable or benchtop validation systems
- Combining sensors and electrical measurements
- Sensor measurements

[See page 28 for more details.](#)



## High-Speed Control with Built-In Computer (CompactRIO)

- Similar hardware and measurements specs of CompactDAQ
- Run code on built-in processor (no PC needed for runtime)
- Program as a controller with sub-second loop rates
- Programmable coprocessor (FPGA) for in-line processing/control from I/O modules
- Program with LabVIEW only

### Best for:

- Rugged monitoring and control applications
- High-speed signal and sensor data logging
- Rapid control prototyping

[See page 30 for more details.](#)



## PXI (PCI Extensions for Instrumentation)

- Combining instruments, sensor, and electrical measurements
- Instruments and DAQ/sensors in one
- Modules for scopes, DMMs, switch/relay, ARB, high-speed digitizer, RF, and more
- Best synchronization
- High-bandwidth connection between I/O, instruments, and processors
- Run with on-board PXI controller (PC components) or connect to PC/laptop
- Open standard: multiple PXI vendors in the T&M market

### Best for:

- Production test systems for electronic devices
- Automated validation test
- High-channel, high-speed test applications

[See page 34 for more details.](#)



## RF Hardware

- Vector signal transceivers
- USRP software defined radios

### Best for:

- Wireless design and test
- RFIC validation and production testing
- Radar prototyping
- Multi-channel test beds

[See page 52 for more details.](#)



## Instrument Control

- GPIB and serial conversion to USB, PCI(e), and Ethernet
- Simplified instrument control using LabVIEW prebuilt drivers

### Best for:

- Connecting your PC to boxed instruments from companies such as Keysight, Rode & Schwartz, and Tektronix

[See page 56 for more details.](#)



NI PXI used with TestStand in an RF manufacturing test system



PXI used for benchtop validation system



CompactRIO in an industrial enclosure installed in a power plant



CompactDAQ in an industrial enclosure as part of engine test cell



# PC-Based Data Acquisition (Multifunction I/O and Reconfigurable I/O)



Hardware in the PC-Based Data Acquisition family either installs inside your computer on the motherboard, like you would install a new graphics card, or are external devices you connect with a USB cable. Use PC-based data acquisition to turn your Windows PC or laptop into a measurement system. Desktop systems are common for validation test. They can be deployed to manufacturing lines, though many companies prefer to upgrade to PXI for the reliability and easier integration with test racks. Multifunction I/O devices, the most typical PC-based hardware from NI, are cost optimized for  $\pm 10$ -volt inputs/outputs, TTL digital lines, and counter/timer functionality. Multifunction devices are highly versatile and ideal for measuring sensors with a voltage output,  $\pm 10$  V electrical signals, current measurements over a shunt resistor, pulse and event signals from meters, quadrature encoders, simple TTL digital lines, and more.

Select a Reconfigurable I/O device if you are controlling lasers, galvo mirrors, want to offload processing for real-time data analysis, or are running HIL simulations, developing custom digital protocols, prototyping control systems, or other input/output applications where timing is critical. These systems are more advanced.

Turn your PC into a custom measurement system by selecting the right device.

- [Multifunction I/O device selection table \(page 26\)](#)
- [Reconfigurable I/O device selection table \(page 27\)](#)



Recommended software (sold separately):

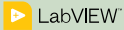

Included software and programming support:

C/C++, C#, Python, CVI

## Multifunction I/O: PCIe, USB

Multifunction I/O devices have a mix of I/O with varying channels, sample rates, output rates, and other features to meet common measurement requirements.

### Specifications include:

- 12-bit to 18-bit analog input resolution
- Up to 80 analog channels and 48 bidirectional channels
- Up to 5 MS/s/ch analog sample rate

### Key Features:

#### Built for Accuracy and Reliability

Analog signal paths have been meticulously designed, tested, and calibrated to ensure the highest possible accuracy is achieved across all input channels.

#### Advanced Timing

Technology on-board timing circuitry controls analog, digital, and counter I/O lines—providing up to four enhanced counters, a 100 MHz timebase, and additional options for I/O timing and triggering.

#### System Flexibility

Choose from a variety of channel combinations of analog I/O, digital I/O, and counter/timer functionality in a single device.

### Popular Multifunction I/O Devices

For legacy products (PCI) or other Multifunction I/O options, contact your NI product expert or authorized reseller.

MODEL	SAMPLE RATE	ANALOG INPUT RESOLUTION	I/O CHANNEL COUNTS				
			SINGLE-ENDED ANALOG INPUT	DIFFERENTIAL ANALOG INPUT	ANALOG OUTPUT	BIDIRECTIONAL DIGITAL	COUNTERS/TIMERS
PCIe-6320	250 kS/s	16 bits	16	8	—	24	4
PCIe-6321	250 kS/s	16 bits	16	8	2	24	4
PCIe-6323	250 kS/s	16 bits	32	16	4	48	4
PCIe-6351	1.25 MS/s	16 bits	16	8	2	24	4
PCIe-6363	2 MS/s	16 bits	32	16	4	48	4
USB-6001	20 kS/s	14 bits	8	4	2	13	1
USB-6210	250 kS/s	16 bits	16	8	—	—	2
USB-6212	400 kS/s	16 bits	16	8	2	24	2
USB-6343	500 kS/s	16 bits	32	16	4	48	4
USB-6363	2 MS/s	16 bits	32	—	4	48	4



Recommended software (sold separately):

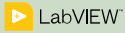

Included software and programming support:

C/C++, Python

## Reconfigurable I/O: PCIe, USB

Reconfigurable I/O devices have an on-board coprocessor (FPGA) that's directly connected to the measurement pins. Unlike a Multifunction I/O board where the data takes time to move through the PCIe bus or USB to the processor, Reconfigurable I/O boards connect data from the measurement pins directly to the FPGA running your code. This direct connection takes less time and is great for low-latency applications where timing is critical. Purchase the LabVIEW FPGA Module, a LabVIEW add-on, to develop code for Reconfigurable I/O devices.

Reconfigurable I/O device specifications include:

- 12-bit to 18-bit analog input resolution
- Up to 16 analog channels and 128 bidirectional channels
- Up to 1 MS/s analog sample rate

### Key Features:

#### Flexible Functionality

Match requirements and mimic the functionality of fixed I/O devices with software in timing and triggering applications, such as control and hardware-in-the-loop (HIL) simulations.

#### Embed Logic and Processing

Implement LabVIEW logic and processing in the FPGA including basics like Boolean operations, comparisons, and basic mathematical operations or complex algorithms such as control loops.

#### Define I/O Resources

Create custom measurements using the fixed I/O resources.

MODEL	FPGA	SAMPLE RATE	BIDIRECTIONAL DIGITAL CHANNELS	ANALOG INPUT VOLTAGE RANGE	DIGITAL I/O LOGIC LEVELS	MAXIMUM CLOCK RATE
PCIe-7841	Virtex-5 LX30	200 kS/s	96	-10 V to 10 V	3.3 V, 5 V	40 MHz
PCIe-7842	Virtex-5 LX50	200 kS/s	96	-10 V to 10 V	3.3 V, 5 V	40 MHz
PCIe-7846	Kintex-7 160T	500 kS/s	48	-10 V to 10 V, -5 V to 5 V, -2 V to 2 V, -1 V to 1 V	1.2 V, 1.5 V, 1.8 V, 2.5 V, 3.3 V	80 MHz
PCIe-7852	Virtex-5 LX50	750 kS/s	96	-10 V to 10 V	3.3 V 5 V	40 MHz
PCIe-7820	Kintex-7 160T	–	128	–	1.2 V, 1.5 V, 1.8 V, 2.5 V, 3.3 V	80 MHz
USB-7845	Kintex-7 70T	500 kS/s	48	-1 V to 1 V, -2 V to 2 V, -5 V to 5 V, -10 V to 10 V	1.2 V, 1.5 V, 1.8 V, 2.5 V, 3.3 V	80 MHz
USB-7856	Kintex-7 160T	1 MS/s	48	-1 V to 1 V, -2 V to 2 V, -5 V to 5 V, -10 V to 10 V	1.2 V, 1.5 V, 1.8 V, 2.5 V, 3.3 V	80 MHz

# Modular Data Acquisition for Sensors and Electrical Signals



Recommended software (sold separately):

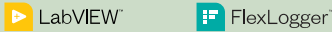

Included software and programming support:

C/C++, C#, Python, CVI

## CompactDAQ

CompactDAQ is rugged, modular hardware that connects sensors and electrical signals to a PC over Ethernet or USB. The available measurement modules, expandability, and software support make CompactDAQ an ideal “universal test instrument” for teams trying to do more with less. Use CompactDAQ for vibration analysis, motor and bearing tests, thermal tests, power quality measurements, reading industrial digital lines, impact/strain tests, and many more test applications.

### Best for:

- High-speed sensor measurements
- Portable or benchtop validation systems
- Combining sensors and electrical measurements

### Key Features:

- **Precise Measurements**  
Choose from more than 70 modules with built-in sensor or signal-specific conditioning. Mix and match to build a customized system that meets your measurement needs.
- **System Scalability**  
Expand your system with Ethernet-compatible CompactDAQ chassis to take  $\mu$ s-synchronized measurements across multiple chassis.
- **Compact, Rugged Design**  
Pack it up and take it with you between labs, to field tests, or to a customer site to validate in-situ data with your test equipment.

# Steps for Building a cDAQ System



## 1. Modules

Use the Measurement & Control Modules (C Series Modules) section to select your modules. [Page 32](#)



## 2. Chassis

Use the following Chassis Selection Table to select your chassis.

Chassis Selection Table

MODEL	CONNECTION TO PC	NUMBER OF MODULES CHASSIS CAN HOLD	SYNCHRONIZE MEASUREMENTS BETWEEN CHASSIS?	DIGITAL TRIGGER BUILT INTO CHASSIS?	OPERATING TEMPERATURE
cDAQ-9171	USB 2.0	1	No	No	-20 °C to 55 °C
cDAQ-9174	USB 2.0	4	No	No	-20 °C to 55 °C
cDAQ-9178	USB 2.0	8	No	Yes	-20 °C to 55 °C
cDAQ-9179	USB 3.0	14	No	Yes	-20 °C to 55 °C
cDAQ-9181	Ethernet	1	No	No	0 °C to 55 °C
cDAQ-9185	Ethernet	4	Yes	Yes	-40 °C to 70 °C
cDAQ-9189	Ethernet	8	Yes	Yes	-40 °C to 70 °C

# High-Speed Control with Built-In Computer



Recommended software (sold separately):

▶ LabVIEW<sup>®</sup>    LabVIEW Real-Time Modules    LabVIEW FPGA Module

Included software and programming support:

C/C++, C#, Python, CVI

## CompactRIO

CompactRIO is a rugged, modular data acquisition and control system that includes a built-in computer and programmable FPGA. The FPGA connects to the measurement modules for a shorter data processing path and better control over I/O timing. CompactRIO is great for rapid control prototyping, high-speed data logging applications in rugged environments, and advanced control where a PLC doesn't have the performance required.

### Best for:

- Rugged monitoring and control applications
- High-speed signal and sensor data logging
- Rapid control prototyping

### Key Features:

- **Program with LabVIEW**  
Use one software environment, LabVIEW, to build and deploy time-critical applications. Program both the processor and user-programmable FPGA without having to program in HDL/VHDL (hardware design languages).
- **Rugged Specifications**  
Deploy in harsh environments with confidence. CompactRIO operates in temperatures from -40 °C to 70 °C and withstands shocks/vibration of 50 g/5 g.
- **Combined Control and Instrumentation-Grade Measurements**  
Integrate high-speed waveform measurements for voltage, vibration, strain, and more with analog and digital control signals for a full-custom test and control system.
- **Linux RTOS (real-time operating system)**  
Harness the openness and reliability of the NI Linux Real-Time OS through thousands of open-source applications, IP, and examples, while collaborating with an active community of users and developers.

# Steps for Building a cRIO System



## 1. Modules

Use the Measurement & Control Modules to select your modules.



## 2. Chassis

Use the following Controller Selection Table to select your chassis with built-in controller.

Select one of our popular controllers (the chassis and controller are integrated and can't be separated)

MODEL	SLOTS	PROGRAMMABLE WITH LABVIEW AND NI-DAQMX DRIVER (EASIER)	PROGRAMMABLE WITH LABVIEW FPGA (ADVANCED)	Processor	FPGA COPROCESSOR
cRIO-9030	4	No	Yes	1.33 GHz Dual Core Intel Atom	Good
cRIO-9035	8	No	Yes	1.33 GHz Dual Core Intel Atom	Good
cRIO-9038	8	No	Yes	1.33 GHz Dual Core Intel Atom	Better
cRIO-9039	8	No	Yes	1.91 GHz Quad Core Intel Atom	Best
cRIO-9040	4	Yes	Yes	1.30 GHz Dual Core Intel Atom	Good
cRIO-9045	8	Yes	Yes	1.30 GHz Dual Core Intel Atom	Good
cRIO-9047	8	Yes	Yes	1.60 GHz Quad Core Intel Atom	Good
cRIO-9049	8	Yes	Yes	1.60 GHz Quad Core Intel Atom	Best
cRIO-9053	4	Yes	Yes	1.33 GHz Dual Core Intel Atom	Good
cRIO-9056	8	Yes	Yes	1.33 GHz Dual Core Intel Atom	Good

# Measurement & Control Modules (C Series Modules)

Install C Series modules in CompactRIO and CompactDAQ chassis for a custom measurement system that meets your needs. The following table is an overview of all C Series module specifications. See the Module Selection Table on the next page to select specific modules.

## C Series Module Specification Overview

SIGNAL TYPE	CHANNEL COUNT	MEASUREMENT TYPES	MAX SAMPLE RATE	SPECIAL FEATURES
<b>ANALOG INPUT</b>				
Voltage	Up to 32	Options for $\pm 200$ mV, $\pm 500$ mV, $\pm 1$ V, $\pm 5$ V, $\pm 10$ V, $\pm 60$ V, $3 V_{\text{rms}}$ , $400 V_{\text{rms}}$ , $800 V_{\text{rms}}$ , $300 V_{\text{rms}}$	20 MS/s/ch	Up to channel-channel isolation, anti-aliasing, and configurable filtering
Current	Up to 16	Options for $\pm 20$ mA, $0 - 5 A_{\text{rms}}$ , $0 - 20 A_{\text{rms}}$ , $0 - 50 A_{\text{rms}}$	200 kS/s	Up to channel-channel isolation, built-in channel diagnostics
Voltage and Current	16	Options for $\pm 20$ mA and $\pm 10$ V	500 S/s	channel-earth isolation, built-in noise rejection
Universal	Up to 4	V, mA, TC, RTD, Strain, $\Omega$ , IEPE	51.2 kS/s/ch	Up to channel-channel isolation, bridge completion, anti-aliasing filters, built-in shunt resistors, amplification
Thermocouple	Up to 16	J, K, T, E, N, B, R, and S types	95 S/s/ch	Up to channel-channel isolation, amplification, filtering, CJC
RTD	Up to 8	100 $\Omega$ , 1000 $\Omega$	400 S/s	50/60 Hz filtering, bank isolation
Strain/ Bridge Based	Up to 8	$\frac{1}{4}$ , $\frac{1}{2}$ , full bridge (120 or 350 $\Omega$ )	50 kS/s/ch	External excitation, bridge completion, anti-aliasing filters
Sound and Vibration	Up to 8	$\pm 5$ V, $\pm 30$ V	102.4 kS/s/ch	IEPE, anti-aliasing filters
<b>ANALOG OUTPUT</b>				
Voltage <sup>1</sup>	Up to 16	Options for $3 V_{\text{rms}}$ , $\pm 10$ V, $\pm 40$ V (stacked)	1 MS/s/ch	Up to bank isolation
Current <sup>2</sup>	Up to 8	$\pm 20$ mA	100 kS/s/ch	Channel-earth isolation, built-in open-loop detection
<b>DIGITAL I/O</b>				
Input/Output	Up to 32	Options for TTL (3.3 V or 5 V) RS422, 5 V, 12 V, 24 V, 48 V, 72 V, 96 V, 120 V AC, 120 V DC, 240 V AC, 240 V DC	55 ns	Up to channel-channel isolation, sinking or sourcing input, bidirectional channel options
Relay Output	Up to 8	Options for 60 V DC, $30 V_{\text{rms}}$ , $250 V_{\text{rms}}$	1 op/s	Up to channel-channel isolation, SPST, or SSR relays
<b>COMMUNICATION BUSES</b>				
CAN	1	HS/FD, LS/FT CAN	1 Mb/s	–
LIN	1	LIN	20 kb/s	–
Serial Interface	4 ports	RS232, RS485/RS422	921.6 kb/s	–



The following table lists the top C Series Modules by category. Use it to match your need to a model number. Didn't find exactly what you're looking for? There are more than 70 C Series Modules; contact your NI Product Expert or authorized reseller for help.

## Module Selection

	SELECTION CRITERIA	SPECIFICATIONS	MODEL NUMBER
Voltage Input	Start here. General purpose.	±10 V, 16-ch DI, 32-ch SE, 16-bit, 250 kS mux, gain settings	NI 9205
	Faster rate. Still high-density.	±10 V, 16-ch, 100 kS/s/ch simultaneous. No gain.	NI 9220
	24-bit resolution. 250 V ch-ch isolation.	±10 V, 4-ch, 50 kS/s/ch	NI 9239
	60 V input range	±60 V version of NI-9239	NI 9229
	Lowest cost simultaneous sampling	±10 V, 4-ch, 100 kS/s/ch	NI 9215
	Highest speed simultaneous sampling	±10 V, 4-ch, 1 MS/s/ch	NI 9223
	Medium speed, medium cost.	±10 V, 4-ch, 500 kS/s/ch	NI 9222
	Selectable filter, noise rejection	±10 V, 16-ch, 24-bit, 10 kS/s/ch	NI 9202
	Digitizer functionality	±20 MS/s/ch Digitizer. 14-bit.	NI 9775
	Low cost, high-speed 12-bit	±10 V, 8-ch, 12-bit	NI 9201
Voltage Output	Start here. General purpose.	±10 V, 16-ch, 25 kS/s/ch	NI-9264
	Lower cost and channels. Faster.	±10 V, 4-ch, 100 kS/s/ch	NI-9263
	Ch-Ch Isolated Output, 40 V range	±10 V or ±40 V, 4-ch, 100 kS/s/ch	NI-9269
Thermocouple	Start here. General purpose.	16-ch	NI-9213
	More accuracy (0.37 C° benchmark)	More accurate version of NI-9213	NI-9214
	CH-CH isolation or TC minijack connectors	8-channel, ch-ch iso, mini TC jacks	NI-9212
Accelerometer and Microphone	Start here.	4-ch, 51.2 kS/s/ch, ±5 V	NI-9234
	2x faster sample rate, 30 V range	3-ch, 102.4 kS/s/ch, ±30 V	NI-9232
	More channels/module	8-ch, 51.2 kS/s/ch, ±5 V	NI-9231
	Lower cost	12.8 kS/s/ch version of the NI-9232	NI-9230
Bridge, Strain, Load, Pressure, Torque	Start here. General purpose.	4-ch, 50 kS/s/ch, 1/4, 1/2, Full-bridge	NI-9237
	More than 2x 120 Ohm ¼ bridge sensors	8-channels	NI-9235
RTD Temperature	Start here. General purpose.	8-ch, 400 S/s, 0Ω - 400Ω, PT100	NI-9216
Universal	Start here. General purpose.	4-ch, ch-ch ISO, 100 S/s/ch, strain gages, RTD, Thermocouple, Load Cell, ½-, ¼-, Full-bridge Completion	NI-9219
Current Input	Start here. General purpose.	±20 mA, 8-ch, 200 kS/s	NI-9203
	More ch/module, 24-bit, 50/60 Hz rejection	±20 mA, 16-ch, 500 S/s	NI-9208
Digital Input and Output	Industrial DIO	32-ch (16I/16O), 12 V/24 V industrial level	NI-9375
	High channel-count 24 V DO	32-ch, 12 V/24 V industrial level DO	NI-9476
	TTL	8-ch, 5 V TTL	NI-9401
	High channel-count TTL	32-ch, 5 V TTL	NI-9403
	High channel-count 24 V DI	32-ch, 12 V/24 V industrial level DI	NI-9425
	Relay	250 VAC, 60 VDC, 4 relays	NI-9482
	Industrial DI	8-ch, 12 V/24 V DI	NI-9421
	Industrial DO	8-ch, 12 V/24 V DO	NI-9472
POWER (CURRENT AND 120+ VAC)	Voltage: Start here	3-ph 250 VAC L-N (400 VAC L-L) 50 kS/s/ch	NI-9242
	Voltage: 480 VAC	3-ph 400 VAC L-N (800 VAC L-L) 50 kS/s/ch	NI-9244
	Voltage: Ch-Ch ISO Voltage	3 channels, 300 V Pk, 50 kS/s/ch	NI-9225
	Current Low Voltage Transformer Input	Voltage module that connects to 0.33 V CTs	NI-9238
	Current 5 A Secondary CT input	Connects to 5 A CTs (20 A range)	NI-9246
	Current High accuracy, low range	Built-in shunt, 5 A rms input	NI-9227

# PXI Systems



PXI (PCI eXtensions for Instrumentation) refers to a computer for test engineers. Your desktop computer has boards installed in the motherboard for graphics and sound. PXI systems have boards, called modules, for instrument functions like oscilloscopes and for measuring sensors, digital, RF, or electrical signals. You can connect a PXI chassis to a desktop or laptop, but most PXI systems have the computer (called a PXI-embedded controller) built in. These controllers run Microsoft Windows, connect to standard monitors, mice, and keyboards, and have hard drives as well as other normal computer components. PXI has been around since 1997 and follows the same technology curve as the computers you buy for home and office use.

Engineers use PXI systems to reduce test time and improve measurement performance as compared to using multiple boxed instruments connected to a PC moving data over USB or Ethernet. PXI is used widely for automated validation test and for manufacturing test systems.

## Best for:

- Production test systems for electronic devices
- Automated validation test
- High-channel, high-speed test applications
- Combining instruments, sensor, and electrical measurements

## Key Features:

- **Industry Standard**  
You're not locked in. PXI is an open standard with hardware available from more than 60 vendors.
- **High-Performance**  
Test faster with high-bandwidth connections between your measurements, the latest processing technology, and your test software.
- **Scalable**  
Manage change with PXI. Add measurements, more channels, new analysis routines, or upgrade to the latest processor without having to purchase a whole new instrument.
- **Accurate**  
Don't let the size fool you. Some of NI's modular instruments have better specs than comparable boxed instruments.

# Steps for Building a PXI Test and Measurement System



## 1. Instruments (Modules)

Choose your instruments and measurement modules from the PXI Instrumentation Section.



## 2. Controller

For a PXI system with built-in computer:

- Shop for a PXI Embedded Controller just like you would shop for a desktop.
- To connect a PXI chassis to your laptop using a Thunderbolt™ cable, go to the chassis section table and select a chassis with “built-in Thunderbolt cable.”



## 3. Chassis

Use the following Controller Selection Table to select your chassis with built-in controller.



## PXI Chassis

- Up to 8 GB/s per-slot dedicated bandwidth
- Up to 82 W per slot of power and cooling for more advanced I/O modules
- System monitoring for voltage rails, temperature, and fan speed
- Chassis size options from 2 to 18 slots

MODEL	SLOTS	BANDWIDTH	BUILT-IN CABLE TO CONNECT TO A WINDOWS LAPTOP?
PXIe-1071	4	3 GB/s	No
PXIe-1082	8	8 GB/s	No
PXIe-1088	9	8 GB/s	No
PXIe-1092	10	24 GB/s	No
PXIe-1084	18	4 GB/s	No
PXIe-1086	18	12 GB/s	No
PXIe-1095	18	24 GB/s	No
PXIe-1090	2	2 GB/s	Yes (Thunderbolt 3)
PXIe-1083	5	2 GB/s	Yes (Thunderbolt 3)



## PXI Embedded Controller

- High-performance Intel processors
- Operating system options: Windows (7 or 10)\*
- Up to 24 GB/s system bandwidth
- Solid State drives, Thunderbolt 3, USB 3.0, Gigabit Ethernet, and other peripheral ports

PXI Controllers come with standard features such as an integrated CPU, hard drive, RAM, Ethernet, video, keyboard/mouse, serial, USB, and other peripheral I/O. Shop for a PXI Embedded Controller like you would a desktop PC.

	PXIE-8822 LOWEST COST	PXIE-8842	PXIE-8862	PXIE-8881 (8-CORE)	PXIE-8881 (16-CORE) HIGHEST PERFORMANCE
Processor	Intel Core i3	Intel Core i5	Intel Core i7	Xeon 8-Core	Xeon 18-Core
Bandwidth	4 GB/s	8 GB/s	16 GB/s	24 GB/s	24 GB/s

\*NI Linux RT versions are also available; talk to an NI technical expert to determine the right fit for your application.

# PXI Instrument Overview



## Oscilloscopes [Page 38](#)

- Sample at speeds up to 12.5 GS/s
- 5 GHz of analog bandwidth
- Numerous triggering modes
- Up to 24-bit resolution



## Digital Multimeters [Page 39](#)

- Voltage measurements up to 1,000 VDC
- Current measurements up to 3 A
- Resistance measurements up to 5 G $\Omega$
- Isolated Digitizer mode up to 1.8 MS/s



## Counters/Timer [Page 40](#)

- Up to eight 32-bit counter/timers
- TTL/CMOS-compatible digital I/O
- Up to 80 MHz measure frequency
- On-board high-precision oscillators



## Power Supplies [Page 41](#)

- Two isolated, 60 W channels per module
- Hardware timing and triggering
- Output disconnect relays
- Four-wire remote sense



## Switches [Page 42](#)

- Electromechanical, Reed, solid state, FET
- Up to 150 V or 2 A
- Up to 544 cross points in a single PXI slot
- 1- and 2-wire options



## LCR Meter [Page 43](#)

- AC stimulus frequency up to 2 MHz
- AC stimulus amplitude up to 7.07 Vrms
- DC bias up to  $\pm 40$  V
- Basic impedance accuracy of 0.05%



## Digital Instruments [Page 44](#)

- 32-channel module (up to 512 per chassis)
- 100 MHz vector rate, 39 ps displacement
- Digital voltage -2 V to 6 V
- Up to 200 Mb/s data rate



## Waveform Generators [Page 45](#)

- Up to two 16-bit channels per module
- 800 MS/s with 20, 40, and 80 MHz bandwidth
- Up to 34 channels to build parallel
- Max  $\pm 12$  V and min  $\pm 7.75$  mV output ranges



## Source Measure Units (SMU) [Page 46](#)

- Up to 24 channels (408 per chassis)
- Up to 200 V and 3 A (10 A pulse)
- Current sensitivity down to 10 fA
- Max power per channel of 40 W (500 W pulse)



## Reconfigurable IO (FPGA) [Page 47](#)

- Variety of on-board FPGA options
- 12-bit to 18-bit analog input resolution
- Up to 16 analog channels and 96 bidirectional channels
- Up to 1 MS/s analog sample rate



## Digital Waveform Instrument [Page 48](#)

- Standard TTL/CMOS interface voltages and programmable voltage levels
- 32 bidirectional digital channels
- Advanced waveform sequencing and streaming features



## Multifunction I/O [Page 49](#)

- Analog I/O, Digital I/O, and counters in a single device
- High-speed simultaneous sampling up to 14 MS/s/ch
- Up to 836 AI single-ended channels in 4U of rack space



## Sound and Vibration [Page 50](#)

- Built-in high-pass filtering
- Reliably characterize dynamic signals
- Per-channel, software-selectable AC input coupling
- Per-channel, software-selectable input gain settings





## Signal Conditioning Modules [Page 51](#)



- High channel density for conditioned and sensor measurements
- Flexible, synchronized, and accurate measurements
- Isolated measurement options
- Swappable front mount terminal block



Recommended software (sold separately):

 LabVIEW<sup>®</sup>
 RFmx

Included software and programming support:

 InstrumentStudio<sup>®</sup>
 C/C++
  C#
  Python
  CVI

## PXI Oscilloscopes

- Sample at speeds up to 12.5 GS/s
- 5 GHz of analog bandwidth
- Numerous triggering modes
- Up to 24-bit resolution

### Key Features:

#### Deep On-Board Memory

PXI Oscilloscopes feature deep on-board memory, capable of storing multiple acquisitions from single channels or parallel acquisitions from multiple channels on the same device.

#### CableSense™ Technology

CableSense technology can reduce risk of faulty electrical connection by detecting changes from a known, golden setup without having to alter the connections themselves.

#### Automatic Synchronization

The same model scopes will synchronize in a PXI chassis for high-channel scope applications.

MODEL	CHANNELS	RESOLUTION	BANDWIDTH	SAMPLE RATE	MEMORY SIZE	BUILT-IN FPGA
PXIe-5105	8	12 bits	60 MHz	60 MS/s	512 MB	No
PXIe-5113	2	8 bits	500 MHz	3 GS/s	512 MB	No
PXIe-5114	2	8 bits	125 MHz	250 MS/s	256 MB/ch	No
PXIe-5122	2	14 bits	100 MHz	100 MS/s	256 MB/ch	No
PXIe-5160	4	10 bits	500 MHz	2.5 GS/s	2 GB	No
PXIe-5162	4	10 bits	1.5 GHz	5 GS/s	2 GB	No
PXIe-5164	2	14 bits	400 MHz	1 GS/s	1.5 GB	Yes
PXIe-5170	8	14 bits	100 MHz	250 MS/s	1.5 GB	Yes
PXIe-5171	8	14 bits	250 MHz	250 MS/s	1.5 GB	Yes
PXIe-5172	8	14 bits	100 MHz	250 MS/s	1.5 GB	Yes
PXIe-5186	2	8 bits	5 GHz	12.5 GS/s	32 MB	No
PXI-5922	2	24 bits	6 MHz	15 MS/s	256 MB/ch	No



Recommended software (sold separately):



Included software and programming support:



## PXI Digital Multimeters

- Voltage measurements up to 1,000 VDC
- Current measurements up to 3 A
- Resistance measurements up to 5 GΩ
- Isolated Digitizer mode up to 1.8 MS/s

### Key Features:

#### Most Accurate 7.5-Digit DMM

With 26 bits of resolution and high stability, NI DMMs outperform traditional box DMMs.

#### Customizable Settings

NI DMMs give you the ability to programmatically customize measurement settings to prioritize speed or accuracy.

#### Isolated Digitizer Mode

Isolated, high-voltage digitizer mode with sample rates up to 1.8 MS/s—36X faster than traditional DMMs

	PXI-4065	PXI-4080	PXI-4081	PXI-4082
Resolution	6.5 Digit	6.5 Digit	7.5 Digit	6.5 Digit
Voltage	-300 V to 300 V	-300 V to 300 V	-1000 V to 1000 V	-300 V to 300 V
Current	-3 A to 3 A	-1 A to 1 A	-3 A to 3 A	-1 A to 1 A
Sample Rate	3 kS/s	1.8 MS/s	1.8 MS/s	1.8 MS/s



Recommended software (sold separately):



Included software and programming support:

C/C++, C#, Python, CVI

## PXI Counter/Timer

- Up to eight 32-bit counter/timers
- Up to 80 MHz measure frequency
- TTL/CMOS-compatible digital I/O
- On-board high-precision oscillators

The PXI Counter/Timer Module performs encoder position measurement, event counting, period measurement, pulse-width measurement, pulse generation, pulse-train generation, and frequency measurement.

	PXI-6602	PXI-6608	PXI-6624	PXIE-6612	PXIE-6614
Number of Counters/Timers	8	8	8	8	8
Measure Frequency	80 MHz	80 MHz	400 kHz	80 MHz	80 MHz
On-Board High-Precision Oscillator	No	Yes	No	No	Yes





Recommended software (sold separately):



Included software and programming support:

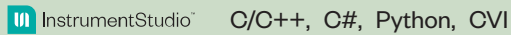

## PXI Power Supply

- Up to 60 W per channel or 120 W per module
- Hardware timing and triggering
- Built-in voltage and current readback
- Four-wire remote sense

PXI Programmable Power Supply modules feature multiple channels that can combine for higher voltage or current capabilities. Some modules include isolated channels and an output disconnect functionality to isolate from the device under test (DUT) when not in use and remote sense to correct for losses in system wiring.

	NI PXI-4110 POWER SUPPLY	NI PXIE-4112 POWER SUPPLY	NI PXIE-4113 POWER SUPPLY
Channel Count	3	2	2
Output Voltage Range	-20 V to 20 V	0 V to 60 V	0 V to 10 V
Max Current (per channel)	1 A	1 A	6 A
Total Power (per module)	46 W	120 W	120 W



Recommended software (sold separately):

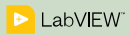

Included software and programming support:

C/C++, C#, Python, CVI

## PXI Switches

- 100+ different switching topologies
- Up to 600 V and 40 A
- Bandwidth up to 40 GHz
- Up to 544 matrix crosspoints
- 1- wire, 2- wire, and 4-wire options
- Software selectable topologies offer flexibility

### Key Features:

#### PXI Switch Expansion

Physically combine multiple PXI switches to create a single, larger switch by either joining the rows/columns of PXI matrices or by joining the COMs of PXI multiplexers.

#### Synchronize with Instruments

Perform hardware handshaking to synchronize a PXI switch with another PXI instrument, removing the software overhead and bus latency.

#### Switch Executive Software

Application software for intelligent switch management and routing that accelerates development and simplifies maintenance of complex switch systems.



Recommended software (sold separately):  LabVIEW	Included software and programming support: C/C++, C#, Python, CVI
--	--

## PXI LCR Meter (and SMU)

- AC stimulus frequency up to 2 MHz
- AC stimulus amplitude up to 7.07 Vrms
- DC bias up to  $\pm 40$  V
- Basic impedance accuracy of 0.05%

NI's LCR & SMU ensures the speed, accuracy, usability, and repeatability needed to efficiently perform DC and impedance measurements in a variety of applications. They are capable of measuring femtofarad-class capacitance measurements and femtoampere-class current measurements in a single-slot PXI form factor.

PXIE-4190 PRODUCT VARIANTS		
Max Frequency	2 MHz	500 kHz
Max Voltage/DC Bias	+/- 40 V (AC + DC)	+/- 10 V (AC + DC)
Current Sensitivity	1 fA	1 pA



Recommended software (sold separately): LabVIEW	Included software and programming support: C/C++, C#, Python, CVI
--	--

## PXI Digital Instruments

- 32-channel module (up to 512 per chassis)
- 100 MHz vector rate, 39 ps displacement
- Digital voltage -2 V to 6 V
- Up to 200 Mb/s data rate

Digital Instruments generate and acquire high-speed digital waveforms for transmitting data, communicating with devices under test, or testing digital interfaces. These instruments are designed for semiconductor characterization and production test. They include the Digital Pattern Editor software for configuring pin maps, specifications, levels, timing, and patterns. Additionally, debugging tools are available in software such as Shmoo Plot, digital scope, and viewers for history RAM, pin states, and system status.

	PXIE-6570	PXIE-6571*
Module Width	2 slots	1 slot
Active Load	24 mA	16 mA
Pin Electronics	Digital: -2 V to +6 V, 32 mA PPMU measure voltage: -2 V to +6 V, 32 mA PPMU force voltage: -2 V to +7 V, 32 mA	
Channels	32 per module	
	256 maximum in a synchronized subsystem	512 maximum in a synchronized subsystem



Recommended software (sold separately):

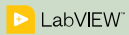

Included software and programming support:



## PXI Waveform Generator

- Up to two 16-bit channels
- 800 MS/s update rate with 20, 40, and 80 MHz bandwidth options
- Up to 34 channels in parallel per chassis
- Maximum  $\pm 12$  V and minimum  $\pm 7.75$  mV output ranges

### Key Features:

#### Waveform Streaming

PXI waveform generator can stream hundreds of megasamples per second to instrument memory.

#### Digital Filtering

PXI waveform generators feature digital filtering designed to remove unwanted frequency images from the generated signal in arbitrary generation mode.

#### Waveform Scripting

Define standard and arbitrary waveforms that can be looped and burst using scripts.

	PXIE-5413		PXIE-5423		PXIE-5433	
Bandwidth	20 MHz		40 MHz		80 MHz	
DAC Resolution; Update Rate	16-bit; 800 MS/s		16-bit; 800 MS/s		16-bit; 800 MS/s	
User-Programmable Arbitrary Waveform	200 MS/s		200 MS/s		400 MS/s Filter On 250 MS/s Filter Off	
Channels	1	2	1	2	1	2
Memory	128 MB	256 MB	128 MB	256 MB	512 MB	1 GB



Recommended software (sold separately):

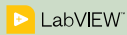

Included software and programming support:



## PXI Source Measure Units (SMU)

- Up to 24 channels (408 per chassis)
- Up to 200 V and 3 A (10 A pulse)
- Current sensitivity down to 10 fA
- Max power per channel of 40 W (500 W pulse)

### Key Features:

#### Unmatched Channel Density

Reduce test time, increase throughput, and meet today's manufacturing requirements by reducing a full rack to a few inches of physical space with up to 408 SMU channels in a single PXI chassis.

#### Built-In IV Sweep

Reconfigure and repurpose the same SMUs across test cases with configuration-based IV sweeps in InstrumentStudio software and a path to more advanced customization in programming environments.

#### High-Power Pulsing

Operate beyond the basic DC power boundary of PXI SMUs by pulsing current or voltage instead of supplying a constant DC source, allowing you to test at high instantaneous power with limited or no heat sink infrastructure.

	Precision System SMUs	4-Channel SMUs	High-Density SMUs
Model numbers	PXIe-413x series	PXIe-414x series	PXIe-416x series
Channels per model (per 4U chassis)	1 (17)	4 (68)	12 or 24 (408)
Max voltage	-200 V to 200 V	-24 V to 24 V	-24 V to 24 V
Max current	-3 A to 3 A	-3 A to 3 A	-100 mA to 100 mA
Best current sensitivity	0.01 pA	0.1 pA	100 pA



Recommended software (sold separately):

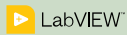

Included software and programming support:

C/C++, Python

## PXI Reconfigurable IO Module (FPGA)

- Variety of on-board FPGA options
- 12-bit to 18-bit analog input resolution
- Up to 16 analog channels and 96 bidirectional channels
- Up to 1 MS/s analog sample rate

### Key Features:

#### Flexible Functionality

Match individual application requirements to mimic the functionality of fixed I/O devices. You also can use with software in timing and triggering applications, such as control and hardware-in-the-loop (HIL) simulations.

#### Accelerate FPGA Programming

The software behind NI R Series modules gives you the flexibility to implement a custom FPGA design from scratch and the support of starting from a host-based driver.

#### Process Signals in Real Time

PXI R Series modules have the resources you need to engineer complex algorithms, process data in real time between the I/O and CPU, and deploy your designs to hardware.

MODEL	FPGA	SAMPLE RATE	BIDIRECTIONAL DIGITAL CHANNELS	ANALOG INPUT CHANNELS	ANALOG OUTPUT CHANNELS	MAXIMUM CLOCK RATE
PXIe-7846	Kintex-7 160T	500 kS/s	48	8	8	80 MHz
PXIe-7857	Kintex-7 160T	1 MS/s	48	8	8	80 MHz
PXIe-7861	Kintex-7 160T	1 MS/s	32	16	8	80 MHz
PXIe-7868	Kintex-7 325T	1 MS/s	48	6	18	80 MHz



Recommended software (sold separately):



Included software and programming support:

C/C++, C#, Python, CVI

## PXI Digital Waveform Instrument

- Standard TTL/CMOS interface voltages and programmable voltage levels
- 32 bidirectional digital channels
- Advanced waveform sequencing and streaming features

PXI Digital Waveform Instruments generate and analyze static and dynamic digital waveforms that interface to digital electronics using single-ended and differential voltage levels. Digital Waveform Devices can be used to create device simulation and complex stimulus-response tests.

	PXI-6544	PXI-6545	PXI-6547	PXIE-6548
Logic levels and range	1.2 V, 1.5 V, 1.8 V, 2.5 V, 3.3 V	1.2 V, 1.5 V, 1.8 V, 2.5 V, 3.3 V	Programmable 1.2 V - 3.3 V	Programmable 1.2 V - 3.3 V
Maximum generation rate	100 Mbits/s	200 Mbits/s	200 Mbits/s	400 Mbits/s
Maximum acquisition rate	100 Mbits/s	200 Mbits/s	200 Mbits/s	300 Mbits/s





Recommended software (sold separately):

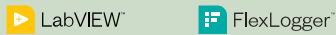

Included software and programming support:

C/C++, C#, Python, CVI

## Multifunction I/O

- Analog I/O, Digital I/O, and counters in single device
- High speed simultaneous sampling up to 14 MS/s/ch
- Up to 836 AI single-ended channels in 4U of rack space

PXI Multifunction I/O Modules offer a mix of I/O with varying channel counts, sample rates, output rates, and other features to meet many common measurement requirements.

MODEL	SAMPLE RATE	ANALOG INPUT RESOLUTION	I/O CHANNEL COUNTS				
			DIFFERENTIAL ANALOG INPUT	SINGLE-ENDED ANALOG INPUT	ANALOG OUTPUT	DIO CHANNELS	SIMULTANEOUS SAMPLING
PXIe-6341	500 kS/s	16 bits	8	16	2	24	no
PXIe-6345	500 kS/s	16 bits	40	80	2	24	no
PXIe-6349	500 kS/s/ch	16 bits	32	0	2	24	yes
PXIe-6355	1.25 MS/s	16 bits	40	80	2	24	no
PXIe-6358	1.25 MS/s/ch	16 bits	16	0	4	48	yes
PXIe-6361	2 MS/s	16 bits	8	16	2	24	no
PXIe-6363	2 MS/s	16 bits	16	32	4	48	no
PXIe-6365	2 MS/s	16 bits	72	144	2	24	no
PXIe-6368	2 MS/s/ch	16 bits	16	0	4	48	yes
PXIe-6375	3.86 MS/s	16 bits	104	208	2	24	no
PXIe-6376	3.57 MS/s/ch	16 bits	8	0	2	24	yes
PXIe-6378	3.57 MS/s/ch	16 bits	16	0	4	48	yes
PXIe-6396	14 MS/s/ch	18 bits	8	0	2	24	yes



Recommended software (sold separately):



Included software and programming support:

C/C++, C#, Python, CVI

## PXI Sound and Vibration Modules

- Dynamic sensor measurements at 51.2 kS/s, 102.4 kS/s, 204.8 kS/s, or 1.25 MS/s
- Built-in high-pass filtering
- Reliably characterize dynamic signals
- Per-channel, software-selectable AC input coupling
- Per-channel, software-selectable input gain settings

PXI Sound and Vibration Modules are designed specifically for applications like audio test and measurement, noise and vibration diagnostics, machine condition monitoring, automotive test, noise, vibration, and harshness (NVH) analysis, and laboratory research. They provide software-configurable AC/DC coupling, antialiasing filters, and IEPE conditioning to ensure precision measurements with microphones, accelerometers, and other transducers with large dynamic ranges.

MODEL	SAMPLE RATE	DIFFERENTIAL ANALOG INPUT CHANNELS	ANALOG OUTPUT CHANNELS	DSA DYNAMIC RANGE	HIGH-PASS FILTER CUT-OFF FREQUENCY
PXI-4461	204.8 kS/s	2	2	118 dB	3.4 Hz
PXIe-4463	51.2 kS/s	–	2	–	3.4 Hz
PXIe-4464	204.8 kS/s	4	–	119 dB	0.72 Hz
PXIe-4492	204.8 kS/s	8	–	114 dB	0.5 Hz
PXIe-4497	204.8 kS/s	16	–	114 dB	0.5 Hz
PXIe-4499	204.8 kS/s	16	–	114 dB	0.5 Hz



Recommended software (sold separately):

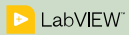

LabVIEW<sup>®</sup>

Included software and programming support:



InstrumentStudio<sup>®</sup>

C/C++, C#, Python, CVI

## PXI Signal Conditioning Modules

- High channel density for conditioned and sensor measurements
- Flexible, synchronized, and accurate measurements
- Isolated measurement options
- Swappable front mount terminal block

NI PXI signal conditioning modules combine the accuracy, high data throughput, and tight synchronization of NI data acquisition modules with integrated signal conditioning for measuring strain gages, bridge-based transducers, thermocouples, and high-voltage analog input signals.

MODULE	MEASUREMENT OR SENSOR TYPE
PXIe-4300	8 Ch-Ch Isolated Voltage (up to 300 V)
PXIe-4309	8-32 Ch Flexible Resolution Module (nanovolt resolution)
PXIe-4310	8 Ch-Ch Isolated Voltage (up to 600 V)
PXIe-4302, PXIe-4303	32 Ch Filtered $\pm 10$ V/ $\pm 0.1$ V Analog Input (5 kS/s/ch and 51.2 kS/s/ch)
PXIe-4304, PXIe-4305	32 Ch Filtered $\pm 42$ V Analog Input (5 kS/s/ch and 51.2 kS/s/ch)
PXIe-4322	8 Ch Isolated Analog Output
PXIe-4330, PXIe-4331	8 Ch Strain and Bridge-Based Sensors (25.6 kS/s and 102.4 kS)
PXIe-4339	8 Ch Bridge and Voltage Input
PXIe-4340	4 Ch AC LVDT, RVDT, Resolver, and Synchro Input
PXIe-4353	32 Ch Bank Isolated Thermocouple
PXIe-4357	20 Ch RTD



# RF



As we push the boundaries of wireless communications, NI offers software defined radios, generators, analyzers, and transceivers for rapid prototyping and production test.



Recommended software (sold separately):

 LabVIEW<sup>®</sup>
 RFmx

Included software and programming support:

 InstrumentStudio<sup>™</sup>

## Vector Signal Transceiver

- Generate and acquire wide instantaneous bandwidth
- Ensure test coverage for new and legacy wireless standards
- Better than -50 dB EVM performance for higher order modulation schemes

The PXI Vector Signal Transceiver (VST) combines a vector signal analyzer and vector signal generator with a user-programmable FPGA and along with high-speed serial and parallel digital interfaces for real-time signal processing and control. With up to 1 GHz of instantaneous RF or complex I/Q bandwidth, the NI VST is ideally suited for a wide range of applications including RFIC validation and production testing, radar prototyping, and other RF wideband test scenarios.

The VST product line provides the high performance necessary to support lab design and validation applications and incorporates the fast measurement speed and small form factor required to scale to production test applications.

	PXIE-5831	PXIE-5841 W/PXIE-5655 LO	PXI-5820
Frequency Range	5 GHz to 21 GHz 22.5 GHz to 44 GHz	9 kHz to 6 GHz	DC to 500 MHz
Instantaneous Bandwidth	1 GHz	1 GHz	1 GHz complex I/Q
RF Channels	Up to 32 In/Out (switched)	1 In 1 Out	1 In, 1 Out Baseband IQ (100 Ohms diff)
EVM (Wi-Fi <sup>®</sup> 6 80 MHz, loopback)	≤ -50 dB	-50 dB	-54 dB
EVM (5G NR 100 MHz, loopback)	0.65 % @ 28 GHz	< 0.35 % @ 3.5 GHz	N/A
VSG Maximum Output Power (CW @ 1 GHz)	+15 dBm @ 6 - 10 GHz +15 dBm @ 28 GHz	≥ +20 dBm	N/A
Tuning Time	see specifications	175 μs	N/A
Supports mmWave Test Heads	Yes	No	No
Digital I/O	8 channels at 60 MHz 4 channels high-speed serial up to 12 Gbps		

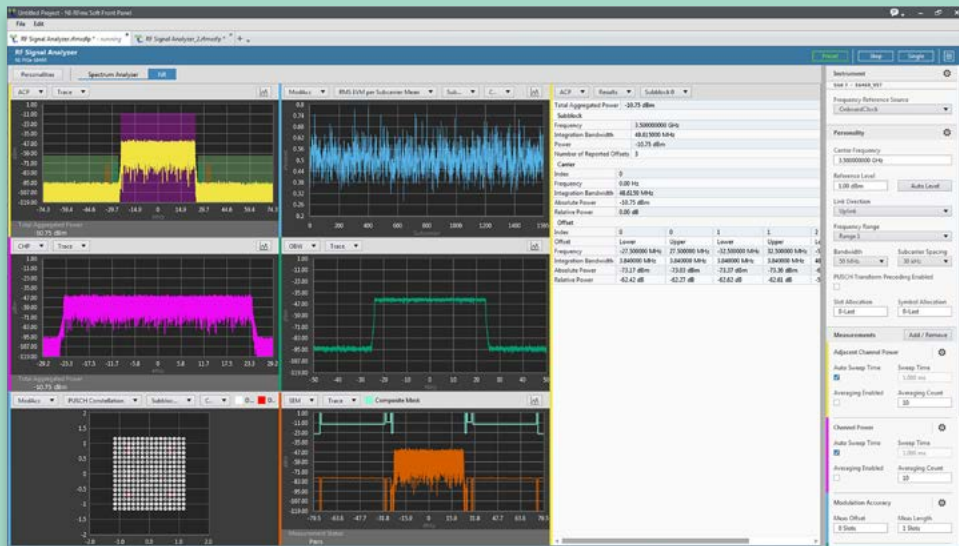

## RFmx

RFmx is a set of interoperable software applications that optimize NI RF instrumentation for general-purpose, cellular, connectivity, and aerospace/defense test applications. RFmx simplifies your signal generation and measurement experience.

### Key Features:

- Standard Compliant**— Test multiple wireless standards for cellular, connectivity, and IoT signals. Select the personality of RFmx for your specific application and testing needs.
- Quick Start**— Begin measurement out-of-the-box with interactive soft front panels and with waveform creation software; generate and modify unlocked waveforms.
- Faster Execution**— Complete testing quicker by taking advantage of innate high-speed measurement algorithms and composite measurement functionality.



## Software Defined Radios

- Frequency ranges between 10 MHz and 6 GHz
- Up to 400 MHz instantaneous bandwidth

NI USRP devices are software defined radios (SDRs) that enable rapid prototyping and deployment of advanced wireless applications. SDRs are used for wireless communications, deploying signals intelligence systems, or as building blocks for multichannel test beds.

TYPE	NI USRP MODEL	NI ETTUS USRP MODEL	#TX	#RX	FREQUENCY RANGE	BW
Stand-Alone, FPGA Enabled High Performance	USRP X410	USRP X410	4	4	1 MHz - 7.2 GHz	400 MHz
	N/A	USRP N320, USRP N321	2	2	3 MHz - 6 GHz	200 MHz
	N/A	USRP N310	4	4	10 MHz - 6 GHz	100 MHz
	USRP-2974	N/A	2	2	10 MHz - 6 GHz	160 MHz
Host Connected, FPGA Enabled, High Performance	USRP-2944	USRP X310 + UBX	2	2	30 MHz - 6 GHz	160 MHz
	USRP-2945	USRP X310 + TwinRx	0	4	10 MHz - 6 GHz	80 MHz
	USRP-2954	USRP X310 + UBX + GPSDO	2	2	30 MHz - 6 GHz	160 MHz
	USRP-2955	USRP X310 + TwinRx + GPSDO	0	4	10 MHz - 6 GHz	80 MHz
Low SWAP Stand-Alone Embedded	N/A	USRP E310/E312/E313	2	2	70 MHz - 6 GHz	56 MHz
	N/A	USRP E320	2	2	70 MHz - 6 GHz	56 MHz
Low SWAP Low Cost USB Connected	N/A	USRP B200mini/B205mini	1	1	70 MHz - 6 GHz	56 MHz
	USRP-2900	USRP B200	1	1	70 MHz - 6 GHz	56 MHz
	USRP-2901	USRP B210	2	2	70 MHz - 6 GHz	56 MHz

No matter your development tool preferences, you can be confident in USRP hardware, which is compatible with the broadest range of software workflows on the market. You can choose LabVIEW for a unified, dataflow programming style or use the open-source driver with support for C, C++, MathWorks MATLAB software, GNU Radio, and more.

# Instrument Control: GPIB, Serial

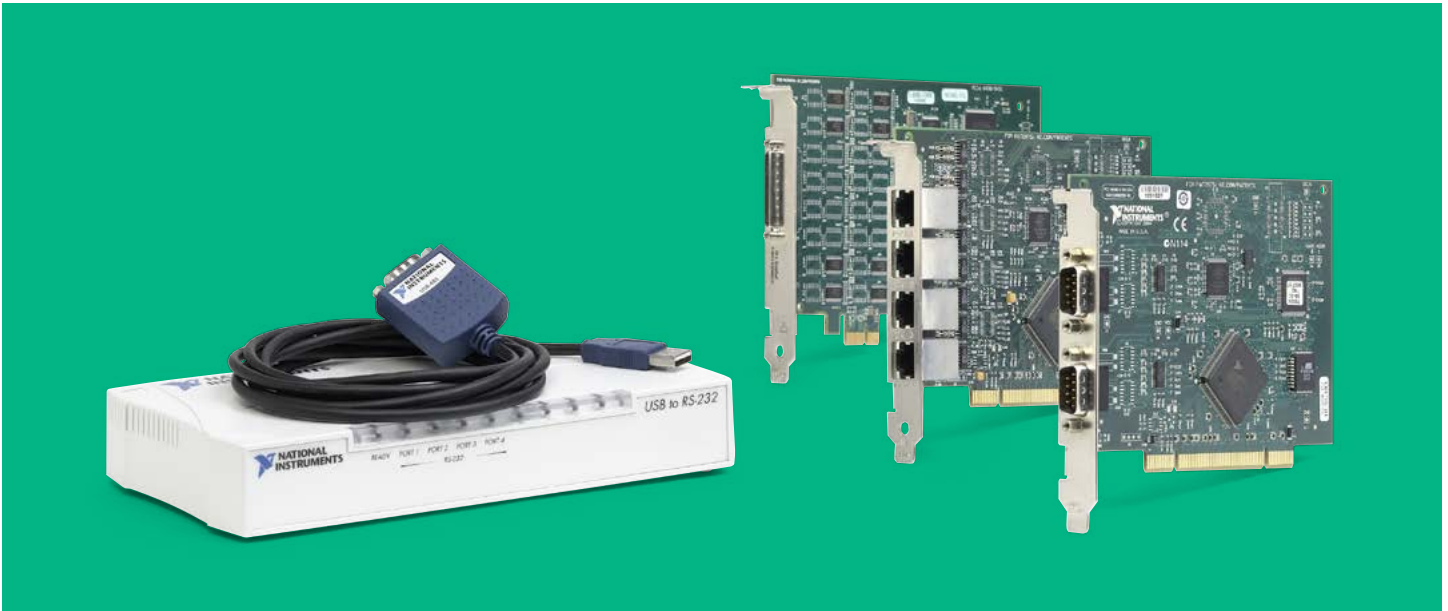

Recommended software (sold separately):  LabVIEW

Too often, powerful box instruments are left on the shelf collecting dust because they communicate using outdated interfaces like Serial and GPIB. NI instrument control hardware can connect these instruments to your laptop or desktop using USB, Ethernet, or PCI(e). We also have thousands of ready-use instrument drivers that make it easy to control your instruments in LabVIEW.

CONNECTION TO YOUR INSTRUMENT	CONNECTION TO YOUR COMPUTER	NOTES	MODEL NAME
GPIB	Ethernet		GPIB-ENET/1000
GPIB	RS232		GPIB-RS232
GPIB	USB 2.0		GPIB-USB-HS
GPIB	USB 2.0	On-Board GPIB Analyzer	GPIB-USB-HS+
GPIB	PCIe		PCIe-GPIB
GPIB	PCIe	On-Board GPIB Analyzer	PCIe-GPIB+
RS232	PCIe	2, 8, and 16 channels	PCIe-8430
RS485, RS422	PCIe	2, 8, and 16 channels	PCIe-8431
RS232	PCIe	2 channels, port-port isolation	PCIe-8432
RS485, RS422	PCIe	2 channels, port-port isolation	PCIe-8433
RS232	USB 2.0	1, 2, and 4 channels	USB-232
RS485, RS422	USB 2.0	1, 2, and 4 channels	USB-485

## LabVIEW for Instrument Control

- 7000+ ready-to-run instrument drivers with examples and documentation
- Plug-and-play functionality for popular vendors like Tektronix, Keysight, Keithley, Rohde & Schwarz, and more
- Get started immediately with open-and-run examples
- Do more with a flexible, scalable software platform

Visit our Instrument Driver Network ([ni.com/idnet](http://ni.com/idnet)) to find and download a driver to communicate with third-party instruments.



# NI Partner Network

The NI Partner Program offers domain, application, and overall test development expertise to help your team get ahead and stay ahead.

- Innovate faster with proven scalable solutions
- Reduce development time and cost through Integration and Consulting assistance

## Types of Partners



### Solution Partners

- Experts in delivering products and solutions to solve your specific automated test or automated measurement application challenges.



### System Integrators

- Specialists in integrating and deploying test and measurement systems, based on your specific requirements and their mature industry capabilities.



### Consultants

- Consultants offer expert project services in areas such as software development, engineering, science, analytics, regulatory compliance, or other specialized skills to support complex systems.



### Distributors

- Globally and regionally accessible, authorized distributors have local knowledge with an understanding of the available NI product portfolio, providing a one-stop option for configuring and sourcing your project needs.

Connect with our global community of trusted NI Partners ready to give your business a competitive edge.

Find a Partner or Solution at [ni.com/findapartner](https://ni.com/findapartner)





# Services

NI offers a variety of services to ensure you can be successful throughout the lifecycle of your application. With global solution centers, NI engineers in more than 40 countries, and a vast network of more than 900 NI Partners, NI service programs help you mitigate risks, develop faster, and reduce costs to achieve your goals.

## Hardware Services

From the moment you unbox your hardware to deployment and maintenance, NI hardware services help you get started quickly and operate efficiently throughout the lifecycle of your test system

ENTITLEMENT	HARDWARE WARRANTY	STANDARD	PREMIUM	DESCRIPTION
Duration at Point of Sale	3 years; included	3 years; optional	3 years; optional	NI enhances warranty coverage with additional service benefits provided with a hardware service program.
Maximum Duration with Renewal	≤5 Years with Service Program	≤5 Years	≤5 Years	NI maintains high performance and availability of your hardware for up to 5 years with a hardware service program. For coverage beyond 5 years, NI provides lifecycle service options.
Extended Repair Coverage (3, 5 years)	✓	✓	✓	NI restores your device's functionality and includes firmware updates and factory calibration.
System Configuration, Assembly, and Test		✓	✓	NI technicians assemble, install software, and test your system per your custom configuration prior to shipment.
Advanced Replacement			✓	NI stocks replacement hardware that can be shipped immediately if a repair is needed.
System RMA			✓	NI accepts the delivery of fully assembled systems when performing repair services.
Technical Support	✓	✓	✓	NI provides access to support resources for your hardware
Calibration Plan (Optional)		Standard	Expedited	NI performs the requested level of calibration at specified calibration interval for the duration of the service program.

# Education Services

Education Services incorporates courses and certification programs from NI to help you proficiently develop applications, work with NI hardware, and more. You can apply your knowledge to reduce development time and increase productivity.



## Customer Education Courses

After attending on-location or virtual classrooms and labs ranging from the fundamentals to advanced specifics, you can become familiar with NI hardware and software.



## Training Entitlements

You can gain unique and unlimited access to all NI training courses and certification programs using credits or training membership.



## Certification Program

With certifications from associate developer to architect for LabVIEW and NI TestStand software, you can join the ranks of the thousands of engineers with NI professional certifications.

NI provides flexible options for purchasing training and certification. Whether you want to make an upfront investment, or pay as you go, NI has offerings to meet a variety of budgetary needs.

### Save money with a training membership

A training membership is a cost-effective way to take multiple instructor-led training courses. This program provides one year of unlimited access to instructor-led training and certification.

### Buy credits now, schedule later

Purchase Education Services Credits now and redeem later for any training or certification offering. Education Services Credits expire after one year.

### Secure a seat in a public course

View NI's global training calendar and secure a seat in an upcoming virtual or classroom instructor-led course.

### Take advantage of on-demand learning

NI Software licenses include one-year access to introductory on-demand learning content so you can onboard quickly. Additional on-demand courses are available for purchase.

### Organize a private training event

NI offers private training events for teams up to 12 students. Private training events can leverage standard NI training courses and include custom materials tailored to your needs.

# Technical Support Services

With the knowledge, experience, and responsiveness of NI applications engineers in more than 30 languages and 40 countries, NI has the technical support resources to ensure your success.

## Access Your NI Standard Technical Support:

### Included with Software

Technical Support included with your software subscription license

### Included with NI Hardware Warranty

3 years of Standard Technical Support is included with all NI hardware through your hardware warranty

US Corporate Headquarters  
11500 N Mopac Expwy, Austin, TX 78759-3504  
T: 512 683 0100 F: 512 683 9300 info@ni.com

# Be a benchtop superhero.

Get NI performance and  
precision with entry-level  
DAQ devices.



Visit [ni.com/shop](https://ni.com/shop) to explore NI's full portfolio  
of products designed to help you.

©2022 NATIONAL INSTRUMENTS. ALL RIGHTS RESERVED. NATIONAL INSTRUMENTS, NI, NI.COM, CABLESENSE, COMPACTDAQ, COMPACTRIO, CVI, DIADEM, FLEXLOGGER, INSTRUMENTSTUDIO, LABVIEW, SYSTEMLINK, AND TESTSTAND ARE TRADEMARKS OF NATIONAL INSTRUMENTS CORPORATION. THE MARK LABWINDOWS IS USED UNDER A LICENSE FROM MICROSOFT CORPORATION. WINDOWS IS A REGISTERED TRADEMARK OF MICROSOFT CORPORATION IN THE UNITED STATES AND OTHER COUNTRIES. MATLAB® IS A REGISTERED TRADEMARK OF THE MATHWORKS, INC. THUNDERBOLT AND THE THUNDERBOLT LOGO ARE TRADEMARKS OF INTEL CORPORATION OR ITS SUBSIDIARIES IN THE US AND/OR OTHER COUNTRIES. OTHER PRODUCT AND COMPANY NAMES LISTED ARE TRADEMARKS OR TRADE NAMES OF THEIR RESPECTIVE COMPANIES.

AN NI PARTNER IS A BUSINESS ENTITY INDEPENDENT FROM NI AND HAS NO AGENCY OR JOINT-VENTURE RELATIONSHIP AND DOES NOT FORM PART OF ANY BUSINESS ASSOCIATIONS WITH NI. 139550

